



# Ray O'Herron CO. INC.

## 2020 BUYER'S GUIDE 2021

**WHELEN**<sup>®</sup>  
TRUSTED TO PERFORM™

Check out the new Argos Remote Control Spot Light from Whelen Featured on **PG. 17**



**F** FEDERAL SIGNAL

Take a look at the Pathfinder Siren/Light Controller from Federal Signal Featured on **PG. 8**



**k** KUSTOM SIGNALS, INC.<sup>®</sup>

See the Raptor RP-1 Dash Radar from Kustom Signals Featured on **PG. 26**



**Pro-gard**<sup>™</sup>  
PRODUCTS LLC.

Check out Pro-Gard's Tri-Lock Weapon Mounting Systems Featured on **PG. 25**



**VOLUME 1 of 4**  
Vehicle & Road Safety Equipment

COVER IMAGE  
COURTESY OF

**WHELEN**<sup>®</sup>  
TRUSTED TO PERFORM™



# 2020 - 2021 BUYER'S GUIDE

## VOLUME 1 OF 4

### TABLE OF CONTENTS

SALES REPRESENTATIVES .....	4-5	TRUNK BOXES AND TRAYS .....	24
LIGHTBARS AND MINI-LIGHTBARS .....	6-7	TRANSPORT AND WEAPON MOUNT SYSTEMS .....	25
SWITCH BOXES, SIRENS AND SPEAKERS .....	8-10	RADAR SYSTEMS AND MESSAGE SIGNS .....	26-27
DASH/DECK/WARNING LIGHTS .....	11	FIRST AID, EMERGENCY GEAR AND ORGANIZERS.....	28-29
WARNING AND SURFACE MOUNT LIGHTS .....	12-16	TRAFFIC CONTROL AND SAFETY GEAR .....	30-32
CHARGERS, ANTI-THEFT AND SPOTLIGHTS .....	17	LOCKOUT AND ENTRY TOOLS .....	33
VEHICLE CONSOLES AND ACCESSORIES .....	18-21	SPIKE SYSTEMS AND TRAFFIC CONTROL .....	34
PUSH BUMPERS AND DOOR PROTECTION .....	22	EXTRA VEHICLE ATTACHMENTS AND SUPPLIES .....	35
PARTITIONS AND TRANSPORT SYSTEMS .....	23		

### OUR SATISFACTION COMMITMENT

Your satisfaction means everything to us.  
The products you purchase from us must live up to your expectations.

On all damaged packages please call ASAP. Shipping errors must be reported within 10 days of receipt. All returns must include a packing slip or copy of invoice. Please include a RA number (return authorization number). However, we accept no returns on **SPECIAL-ORDERED** items or worn/used equipment.

All returns, exchanges, or refunds must be made within 30 days. There will be a 20% restocking fee on returned merchandise that is not our error. The customer must pay shipping on all returned items that are not our error.

### SHIPPING YOUR ORDER

The majority of our merchandise is in-stock for fast delivery. All remaining items will be shipped as soon as available. You should expect an extended date of delivery when the merchandise you have ordered:

- Is shipped indirectly from the manufacturer (i.e. teargas)
- Requires personalization (i.e. badges, name-bars)
- Is of an irregular size or color that is not kept in-stock

If you have any questions regarding the status of your order, please call our toll-free number, 1-800-223-2097. Most items are shipped UPS or Fed Ex and a street address must be provided in order for shipment to be received promptly. Failure to provide proper street address may delay delivery of your order.

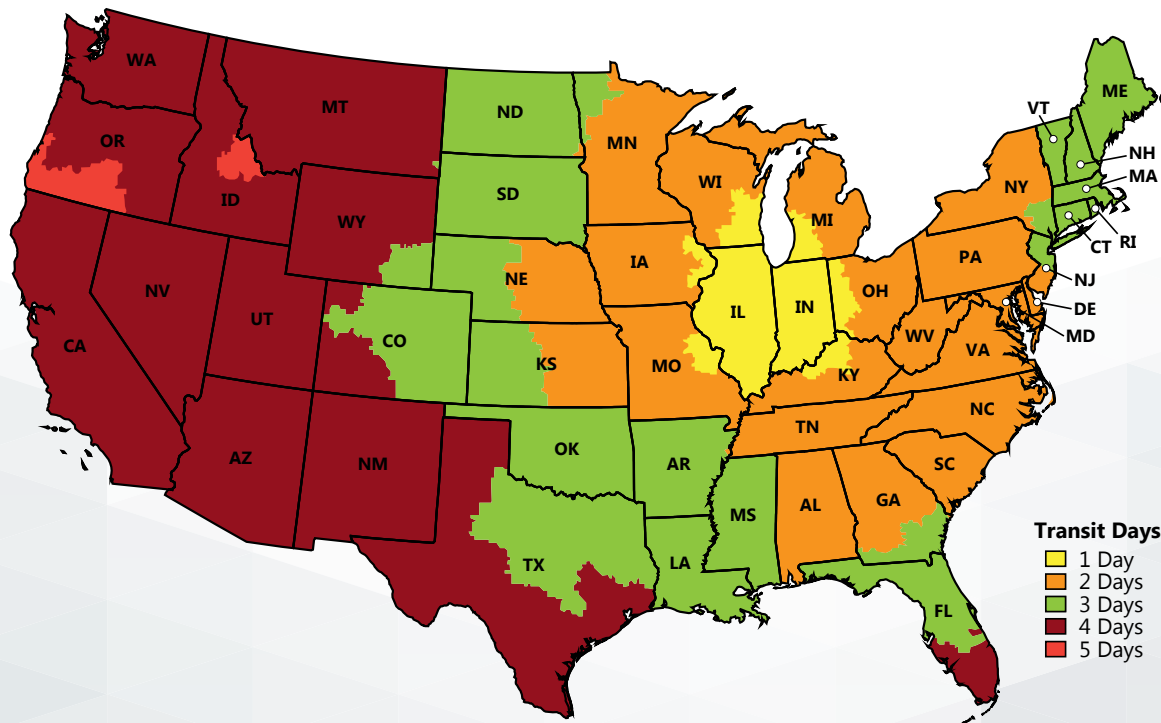



## PRICING POLICY

The pricing in this publication is current upon receipt. Every effort is made to keep our Buyers' Guide error-free, but sometimes a mistake may slip by. In the event of any error, we reserve the right to correct the error. We also offer quantity discounts when purchasing large numbers of a specific SKU. For a quantity price break, please ask your customer service representative for the necessary quantity and its pricing. Retail pricing in our store locations may or may not reflect pricing listed in our Buyers' Guide. For assistance, please call our Customer Service Department.

## IMPORTANT LEGAL NOTICE

Ray O'Herron Company reserves the right to restrict the sale of items we classify as sensitive (badges, handcuffs, batons, body armor, clothing marked POLICE, SHERIFF, SWAT, DEPUTY, etc. and other items). It is O'Herron's position that these type of items should not be allowed to surface within the general population and it is therefore our policy to restrict the sale of these items to officers and agencies. Ray O'Herron Co. can not know or be aware of all the local, state, and federal restrictions regarding the products we sell. Therefore, O'Herron's does not warrant that a person may legally purchase, possess, or carry specific items offered in our Buyers' Guide. If you place an order for these items you guarantee that you are in complete compliance with local, state, and federal laws. These products include, but are not limited to chemical sprays/munitions, ammunition, knives, fuses/flares, crowd control devices, firearms, and other items. When you place an order with us you warrant that you are a legal adult without legal disabilities which would prohibit you from ordering, possessing or transferring these items under applicable federal, state, or local laws. If ordering firearms and/or ammunition, you guarantee that you are at least 21 years of age.

O'Herron's can in no way guarantee that every order will follow these guidelines, but for customers who purchase these sensitive items, he or she guarantees that they are a bona-fide law enforcement officer. Any Department purchases must be paid with a Department check.

## PRIVACY STATEMENT

All information provided by you will be retained by Ray O'Herron Company and may be used for future O'Herron marketing efforts. If for any reason you wish to be removed from our mailing list, not receive future marketing materials, change your personal information, stop receiving a duplicate mailing, or send a Buyers' Guide to a friend please call (800) 223-2097 and a Customer Service Representative will assist you.

## PLACING AN ORDER

When placing an order with us you have many options to choose from: Call us toll-free (1-800-223-2097), Fax us your order (1-888-223-3235—Danville), Email us your order (rayoherron@oherron.com), Visit our website (www.oherron.com), or stop in one of our 2 retail locations!

## PAYING FOR YOUR ORDER

When placing an order with us you may pay by major credit card:



OR pay by personal check or money order. Orders paid by check must include telephone number and will be held for 10 days. There will be a \$25.00 service charge on checks returned for any reason.



## GIFT CARDS AND E-GIFT CARDS

O'Herron Gift Cards and our new special occasion E-Gift Cards are great quick gifts for the special heroes in your life.

# SUPPLIERS OF PUBLIC SAFETY EQUIPMENT SINCE 1964



# 2020 SALES REPRESENTATIVE MAP



**DAN YARA**  
708-710-3396  
dpyara@comcast.net  
*Represents all of Dupage County  
and Southern/Eastern Cook County,  
Central Illinois and Lake County Indiana*



**JIMMY MCNAMARA**  
217-260-3796  
jimmy@oherron.com  
*Northern Indiana (excluding Lake County)*



**JON DELOOSE**  
319-206-6570  
Jond@oherron.com  
*Iowa, Missouri, Rock Island County Illinois*



**SALESMEN TO BE DETERMINED**  
812-657-2121  
*Southern Indiana, Kentucky*



**MICHAEL O'HERRON (SALES DIRECTOR)**  
800-223-2097 [ Ext. 135 ]  
Cell: 217-304-3704 | mike@oherron.com  
*North Dakota, South Dakota,  
Nebraska, Kansas, Ohio, Michigan*



**ADAM HACKLEMAN**  
331-231-0714  
adamh@oherron.com  
*Northern Illinois, Including Chicago*



**JONATHAN MENGES**  
608-282-5211  
jonathanm@oherron.com  
*Wisconsin, Minnesota*



**SALESMEN TO BE DETERMINED**  
217-703-2002  
*Western & Southern Illinois*

## LOCATIONS

### DANVILLE

3549 N. Vermilion | Danville, IL 61832  
Phone: 800-223-2097

### DOWNERS GROVE

1600 75th Street | Downers Grove, IL 60516  
Phone: 630-629-2677

### STORE HOURS

8:00 am to 4:30pm Weekdays CST  
9:00 am to 12:00pm Saturdays CST

## OUR MISSION

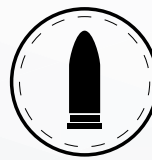

It is our mission at Ray O'Herron Company to strive for excellence through our products and services. We have two store locations to serve you and we also have traveling sales representatives for departments. You can go to our Sales-person tab to find out which sales rep. services your area. If you are not sure, please call or email us so we can assist you.



# REP SUPPORTED STATES

We have local sales representatives that can meet you at your department to discuss your needs. For more information contact one of our rep's in your state.

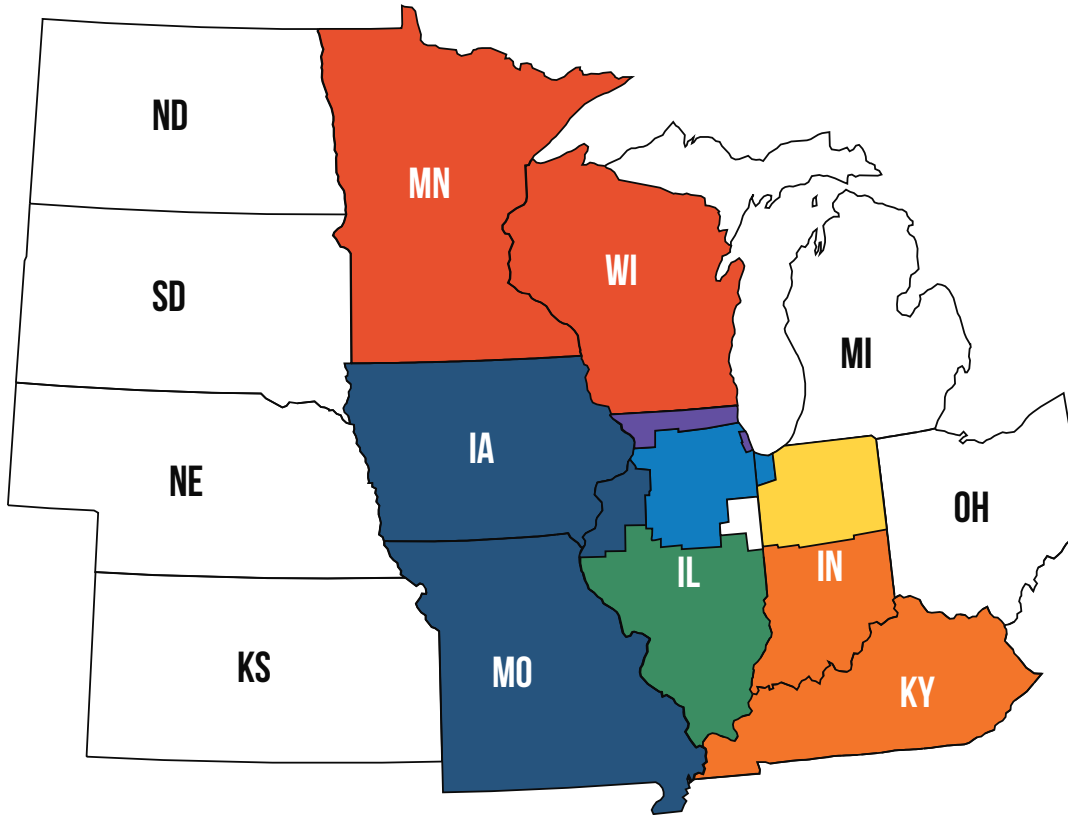

## LEGEND

-  **DAN YARA**
-  **JIMMY MCNAMARA**
-  **JONATHAN MENGES**
-  **ADAM HACKLEMAN**
-  **JON DELOOSE**
-  **TO BE DETERMINED**
-  **TO BE DETERMINED**
-  **MIKE O'HERRON**  
Sales Director

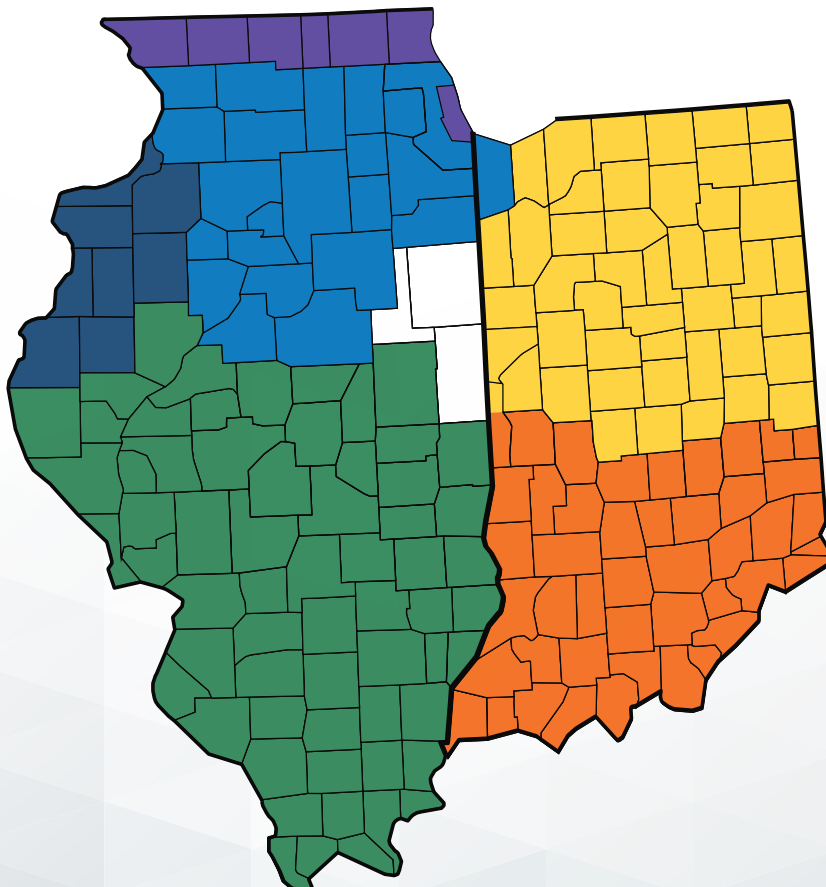

**UP CLOSE**  
Representative territory by county



## CODE 3



### PURSUIT™

Unlimited flash patterns and a convenient interface for easy, customizable programming.  
• Auto dimming with photocell, and selectable dimming levels or each light • Available in 24", 30", 36", 42", 47", 53", 59", 71", and 77" lengths, Dimensions: 13.5" W x 2.3" H

#PT47 PURSUIT Lightbar | Prices starting at **\$917.99**



The bracket system allows the lightbar to be adjusted for height and front/back angle to ensure the lightbar is perfectly level.



### MICRO REFLEX® SERIES

The Micro Reflex® Series LED minibar provides a super-compact yet powerful warning solution • 35 flash patterns for single color or 91 flash patterns for multicolor • 10.9" W x 2.2" H x 7.6" D • Amber & clear lenses available

C5550AA | Micro Reflex | Prices starting at **\$249.99**



### REFLEX® SERIES

The Reflex® Series LED minibar features an innovative design combining Reflective and TIR Optic LED modules to provide superior 360° warning, • 18 flash patterns • 15.3" W x 2.5" H x 9.3" D • Amber & clear lenses available

C5590AA Reflex | Prices starting at **\$384.99**

## FEDERAL SIGNAL



### ALLEGIANT™

Low-profile, dual color, linear light bar • ROC (Reliable Onboard Circuitry) reduces potential failure points • Solaris® LED reflector technology • SpectraLux® LED reflector technology is configurable in combinations of Amber, Blue, Red, White, and Green • Available in 45" and 53" lengths • Auto dim option

AL6T53 | 52.7" length | **\$1,699.99**



### VALOR®

Solaris LED reflector technology • Patented ROC technology • Optional HotFoot for alley and take down or Slate™ camera (ALPR) • Only 2 inches tall (not including mounts) • Available in 44" and 51" lengths

VALR44 | 44" length | **\$2904.99**

VALR51 | 51" length | **\$3195.99**



### INTEGRITY®

SpectraLux multicolor LED technology • Solaris LED reflector technology • Optional HotFoot for takedown, alley and warning lights • Available in 44" and 51" lengths

INT644 | 44" length | **\$2,321.99**

INT651 | 51" length | **\$2,653.99**



### HIGHLIGHTER™ LED PLUS

Low-profile, only 2.7" tall and 15" long • 360-degree light distribution • Solaris® LED reflector technology with 36 LEDs • Split-color models available • LEDs offered in Amber, Blue, Green, Red and White • Domes available in Amber, Blue, Clear, Green and White

454201HL-\*\* | Permanent Mount | **\$404.99**

454200HL-\*\* | Magnetic Mount | **\$439.99**



## LIGHTBARS AND MINI-LIGHTBARS



### OPTIONS

- Rear single color or DUO+Traffic Advisor™
- Take-downs available in 3, 6 or 12 Super-LED modules
- Alley lights available in 3 LED vertical modules

### LIBERTY™ II

#### MODELS

- WeCan models are programmable with unlimited flash patterns
- Plug & Play into Whelen or vehicle manufactured controllers (WeCan only)
- Height without mounting feet is 2.8"
- Available with standard or low profile mounting feet
- Standard lengths: 44", 48" and 54"
- Five year HDP® Heavy-Duty Professional warranty

**SOLO™**—One level, single color

**DUO+™**—One level, single color or two color interleaved

**LIBSPCL** All Red/Blue, 50" model | **\$1,795.00**

**LIBSPCLTA** Red/Blue with Amber in rear, 50" model | **\$1,795.00**

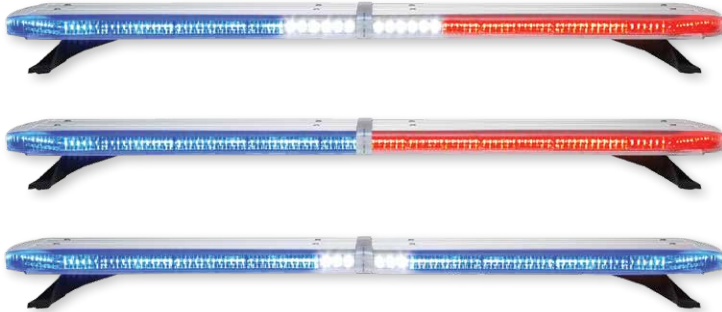

#### GS8SP1J

Legacy™ Single color, 48" lightbar

**\$1,875**

#### GB8SP3J

Legacy™ Duo-color, 48" lightbar [Features two colored lights in one module]

**\$2,249**

### LEGACY™ WECAN®

All warning lighthoods are True DUO+, whether one color or two. Each segment can be operated independently or at the same time, creating the first true DUO lightbar, without loss of intensity; ideal when you want to run a Traffic Advisor™ and rear warning at the same time.

Lower profile than the Liberty but with increased intensity (Height without mounting feet is only 1-5/8") • Legacy "plug and play" into the CenCom Sapphire™ or CanTrol™ controller. • Standard lengths: 44", 48" and 54"



### LEGACY™ DUO+™

Lighthoods available in Amber, Blue, Red and/or White. Options not available on all models, refer to WeCad™ Build-A-Bar Program for lighthood placement.

#### MODELS:

Available in Amber, Blue, Red and/or White DUO+ modules

**GB4\*\*\*\*44" | GB4#### 44" | GB8\*\*\*\*48"**  
**GB8#### 48" | GB2\*\*\*\* 54" | GB2#### 54"**



### JUSTICE® JV WECAN®

High performance, cost competitive Super-LED® lightbar with a wide range of options, designed for ease of operation, upgrade and serviceability.

- Twelve inches wide and only 2.25" high (without mounting feet)
- Three standard lengths 44", 50", 56" plus a 62" Wrecker Bar
- Center section available with single CON3 or two LTR3s™
- Control independent flash pattern
- Optional flashing take-downs and alley lights

**JV4RRBB 45" | Length, Red/Red/Blue/Blue | \$1,395.00**

**JV8RRBB 50" | Length, Red/Red/Blue/Blue | \$1,495.00**



### CENATOR™ LIGHTBAR SERIES

Introducing Whelen's innovative and economic Ceridian Series. Featuring an all-new low-profile design for versatility and convenience. A multitude of options are available, including a center speaker and lighted signs. The Ceridian Series is available with SOLO™, DUO™, or TRIO™ Linear Super-LED® technology.



Prices starting at **\$1,088.99**



## CODE 3



### XCEL™ SIREN

Banshee® siren amp compatible • Volts: 12 • Tones: Air Horn, Hi Lo, Hyper Yelp Manual Wail, Wail, Yelp

**3492L6** Xcel Siren Only | **\$408.99**



### H2 COVERT

Power: 200W • Volts: 12 • Tones: covert AirHorn, covert Hi-Lo, covert Hyper Yelp, covert HyperLo, covert Manual Wail, covert Wail , covert Whoop, covert Yelp

**3599L5** H2 Covert | **\$405.99**



### REMOTE ROCKER MAX PAK SWITCH

The Remote Rocker Max Pak Switch allows users to program, customize, and control unique warning packages with a single switch box.

**450R-L6** Rocker Max Reprogrammable Switch | **\$244.99**

#### TONES:

Air Horn1, Air Horn2, Hi Lo1, Hi Lo2, Hyper Lo1, Hyper Lo2, Hyper Yelp1, Hyper Yelp2, Manual Wail, Wail, Wail Stop, Yelp,



### Z3S MATRIX® SIREN/CONTROLLER

Rotary knob and push-button controller options • All-in-one combo amp with dual-tone/low-frequency capability (optional) • 18 configurable outputs (2 – 20 Amp, 8 – 10 Amp, 8 – 500mA) • 14 discrete, configurable inputs • OBD module add-on option.

**Z3SP-1** Z3S Matrix | **\$989.99**

## FEDERAL SIGNAL



### PA640 SIREN/LIGHT CONTROLLER

Power: 100W • Volts: 11-16 • Tones: Air Horn, Manual, Priority, Wail, Yelp

**640000** | **\$473.10**



### PATHFINDER™ SIREN/LIGHT CONTROLLER

Power: 100/200W • Volts: 12-24 • Tones: Powercall, Air Horn, HI-LO, Priority, Wail, Yelp, Unitrol Air Horn, Unitrol AlarmUnitrol Futura, Unitrol Hetro, Unitrol HI-LO, Unitrol Ultra HI-LO, Unitrol Wail, Unitrol Yelp

**PF200** Pathfinder Dual Tone Siren | **\$799.99**

**PF200R** Pathfinder w/ Remote | **\$995.99**

**PF200S17** Pathfinder w/ 17 Button Controller | **\$1159.99**



### SMARTSIREN PLATINUM® SIREN/LIGHT CONTROLLER

Programmable siren/light controller with remote-mount amplifier • Volts: 11-16 • Tones: Yelp, Wail, Unitrol Yelp, Unitrol Wail, Unitrol Ultra HI-LO, Unitrol HI-LO, Unitrol Hetro, Unitrol Futura, Unitrol Air Horn, SSP3K Yelp, SSP3K Wail, SSP3K Air Horn

**SSP3000B** SmartSiren Platinum | **\$1159.99**



### REMOTE MOUNT SIREN/LIGHT CONTROL

Power: 100W • 22 siren tones including simulated mechanical and manual wail • Auxiliary horn input (Positive or negative input) • "Hands free" 3 tone cycle (tone 1, tone 2, tone 3, off) • 4 Air Horn tones

**LCS869** | **\$318.99**





## SWITCH BOXES, SIRENS AND SPEAKERS



### PCCS9RW POWER CONTROL SWITCH BOX

Front panel programmable slide switch with three 20 amp relays • Six front panel programmable push-button momentary type switches with 20 amp relays • Any switch can be programmed for siren activation • Auxiliary input slide switch, position 3

**PCCS9RW** Power Control Switch Box | **\$241.99**



### 295 SERIES HANDS-FREE SIREN

19 Scan-Lock™ siren tones • 9 individually programmable switches and hard-wired microphone • Each of the 6 push buttons activate one 10 amp output • "Park-Kill" feature • Size, Control Head: 3-5/16" H x 6" W x 7" D

**295SLSA6** 295 Series, Hands-Free Siren | **\$436.80**



**CCSRN4DA**

**CANEM16**

**CCSRN5**

### CENCOM CARBIDE AMPLIFIER CONTROL MODULE

Amplifier Control Module with CANport OBDII interface module Carbide provides the capability to sync all lights together, including a Traffic Advisor™ and the new rear WeCan® Inner Edge® RTX.

Control warning lights, siren, and Traffic Advisor™ functions from a single keypad • New software allows for easy program configuration via USB 2.0 • Fully supports all WeCan® Series products • 12 positive or negative activated inputs • Separate backlight control

**CCRN5** Amplifier Control Module | **\$1706.00**



**CCSRNT4G**



**CCSRNT4F**

### CENCOM CARBIDE™ CONTROL HEADS

Supports up to 2 of the following: front WeCan Inner Edge®, rear WeCan Inner Edge, or optional remote 16 output modules

Control warning lights, siren, and Traffic Advisor™ functions from a single keypad • LED indicator lights allow for simple troubleshooting of outputs and WeCan network • Fully Supports all WeCan® Series products • Supports one or two 100 watt speakers • Supports WeCan dual siren amplifier option • Newly designed software allows for easy program configuration via USB 2.0

**CCSRNT4F** 3 section control head and 8 push-buttons, 4-position slide switch with a 7-position rotary knob, Manual, Airhorn, plus 3 Traffic Advisor switches | **\$1,389.99**

**CCSRNT4G** 3 section control head and 21 push-buttons, 4-position slide switch | **\$1,389.99**

**CCSRN4DA** WeCan External Amplifier | **\$229.99**



**CCSRNT4G**



**CCSRNT4F**

**CANCTL5**



**CANCTL6**



**CANCTL7**

### HHS4200 SIREN & AMPLIFIER

Includes WeCan® port that supports the Inner Edge® FST™ and RST™ Series, WeCan lightbars, and WeCan external amplifier

Windows based software for full customization & configuration • Three control heads available • Operates one or two 100 watt speakers • Eight 10 amp relay outputs, and one 15 amp relay output • Two year warranty

**4200** Siren & Amplifier | **\$849.00**



## WHELEN®

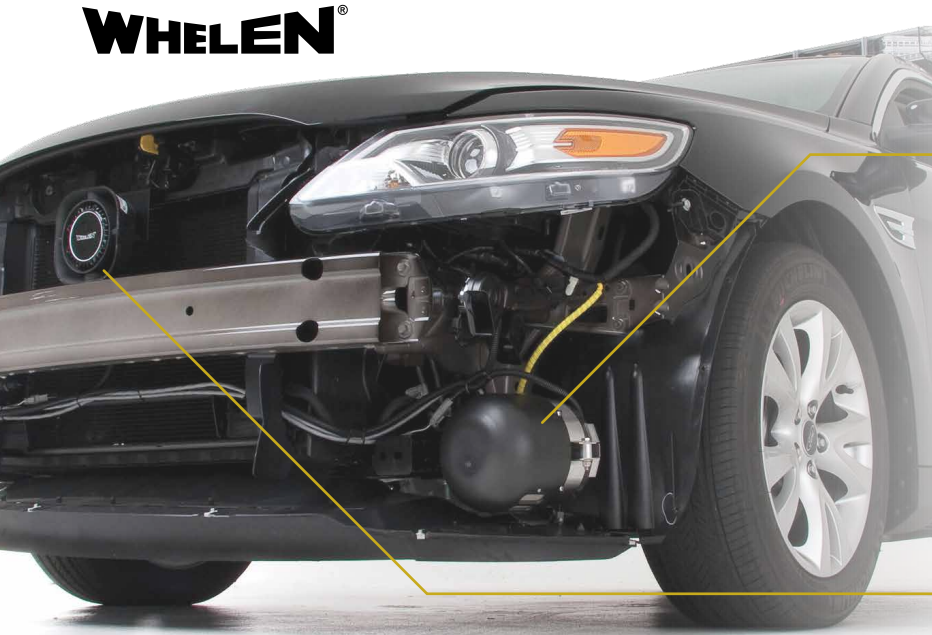

**HOWLER® SERIES LOW FREQUENCY SIREN**  
 Howler is an add-on to any 100/200 watt siren amplifier • Includes low frequency siren amplifier and speaker(s) • Includes 8 different tone durations, 7.5-60 seconds • Includes two external cancel controls • Choose from 12 volt or ground deactivation • 2 year warranty

Howler Low Frequency Sirens | **\$392.60** single  
**\$490.75** dual



Vehicle specific mount brackets are available. Please call us for model info and pricing.



### SA315P SPEAKER & MOUNT

All weather nylon composite black housing with front loaded, powder coated speaker driver • Superior performance in a very small profile package only 2-7/8" in depth • Two year standard Whelen warranty

SA315P Speakers | **\$213.20**  
 SAK9 Universal mount | **\$26.65**

## FEDERAL SIGNAL



### DYNAMAX™ COMPACT SPEAKER

The ES100's slim and lightweight housing mounts easily into the grille. c Slim and lightweight housing—5.9" W x 5.5" H x 2.7" D.

ES100 Speaker | **\$179.00**



Vehicle specific mount brackets are available. Please call us for model info and pricing.

## FEDERAL SIGNAL



### DYNAMAX™ UNIVERSAL MOUNTING KIT

Speaker Mounting Kit, Universal, Length (In.) 10, Width (In.) 12-1/2, Height (In.) 14, For Use With ES100, For Use On All Vehicles, Includes (1) Bracket, Speaker Mounting, (4) Screw, 1/4 In. x 5/8 In., Type B, (4) Lockwasher, Split 1/4 In.

ESB-U Universal mount | **\$32.99**



Vehicle specific mount brackets are available. Please call us for model info and pricing.

### DYNAMAX APPLICATION

A variety of vehicle DynaMax/ES100C mounting brackets are available allowing simple installation.



**STAR SIGNAL**



**LINEUM X™ UNDERCOVER INTERIOR LED LIGHT**

ULB9-HOOD-1 Flash Back Hood included

The New Lineum X™ technology offers an all-mini interior light with 24 Gen4 LEDs • All white takedown/pursuit • 25 customer selectable flash patterns, including steady-on • Independent user selectable color activation • Dimensions: 1-1/6" H x 9" W x 1-3/8" D

Takedown color: White; Color Combos: AW, BW, RB, RW

ULB9LDC | Equipped with dual on/off switch on cig. plug | **\$149.99**

ULB9LDC-1 | Equipped with 12' cable, Can be synchronized | **\$219.99**

**OPTIONS (SOLD SEPARATELY)**

274-ULB9BKT | 3 pc. kit: mirror, deck, and suction cup mount | **\$16.99**

**STAR SIGNAL**



**ULB28 INTERIOR VISOR LIGHT**

Multicolor heads allow single color flash (such as red/red), dual color flash (such as red/white), and will go steady white for "front floor" take down • 31 customer selectable flash patterns • 5 phases • Easy installation with vehicle-specific brackets (*please specify vehicle*).

ULB28-UNI-RWBW Interior Visor Light w/ Brackets | **\$689.00**

**CODE 3**

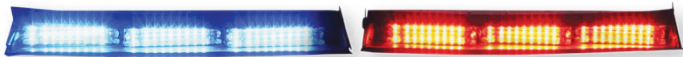

**TORUS SUPERVISOR® FLEX MOUNTING KIT**

SuperVisor Flex is available in MultiColor (18-up) and Single color (9-up) using the latest Torus LED technology. For ease of installation, it also comes with a quick-disconnect center connector cord

SVFSD-6SC SuperVisor Flex, (6) Single Color Torus Lights | **\$937.99**

SVFSD-6MC SuperVisor Flex, (6) MultiColor Torus Lights | **\$1191.99**

**BRACKETS**

SFMTG-TH15 SuperVisor Flex Mounting Kit, Tahoe | **\$130.99**

SFMTG-CH SuperVisor Flex Mounting Kit, Charger | **\$130.99**

SFMTG-PI SuperVisor Flex Mounting Kit, PI Sedan | **\$130.99**

SFMTG-PIU SuperVisor Flex Mounting Kit, PI Utility | **\$130.99**

SFMTG-UNIV SuperVisor Flex Mounting Kit, Universal | **\$175.99**

**CODE 3**



**WINGMAN® FLEX REAR WINDOW INT. LIGHT**

*Perfect Partner to the SuperVisor™*

Single colors are blue, red, amber and white • Multicolors are blue/white, red/white, amber white, red/blue, blue/amber, red/amber • Set of universal L brackets included

WMFLCC09 WingMan Flex, Long, CC, (8)TRS9 Single Color Torus Modules | **\$849.99**

WMFLMC18 WingMan Flex, Long, (8)TRS18 MultiColor Torus Modules | **\$1,136.99**

**OPTIONS**

WMFMTG-PI WingMan Flex Pursuit Bracket for the Interceptor Sedan | **\$50.99**

WMFMTG-CH11 WingMan Flex Pursuit Bracket for the Charger | **\$50.99**

WMFMTG-CP WingMan Flex Pursuit Bracket for the Caprice | **\$50.99**

WMFMTG-IMP WingMan Flex Pursuit Bracket for the Impala | **\$50.99**

**FEDERAL SIGNAL**



8-HEAD FLASHING MODEL



6-HEAD FLASHING MODEL



4-HEAD FLASHING MODEL

**LATITUDE™ SERIES WARNING LIGHT**

Available in 4-head, 6-head or 8-head models • Both interior and exterior mounting brackets are available • Each model includes 10 flash patterns plus 1 test pattern • Three LEDs per position • Five-year Warranty

**4-HEAD FLASHING MODELS**

SL4F-RB | (2) Red, (2) Blue, R-R-B-B | **\$270.99**

SL4F-A | (4) Amber, A-A-A-A (does not include directional functions) | **\$270.99**

**6-HEAD FLASHING MODELS**

SL6F-RB | (3) Red, (3) Blue, R-R-R-B-B-B | **\$396.99**

SL6F-A | (6) Amber, A-A-A-A-A-A (does not include directional functions) | **\$429.99**

**8-HEAD FLASHING MODELS**

SL8F-RB | (4) Red, (4) Blue, R-R-R-R-B-B-B-B | **\$447.99**

SL8F-A | (8) Amber, A-A-A-A-A-A-A-A (does not include directional functions) | **\$481.99**

**MOUNTING BRACKETS**

320310 Flush (vertical surface) mount | **\$31.99**

320330 System mount | **\$44.99**

320340 Universal mount | **\$92.99**

## WARNING AND SURFACE MOUNT LIGHTS



### INNER EDGE® RST

RST™ REAR, SOLO™, DUO™ AND TRIO™

Available for the 2017-2019 Ford F-Series (150 to 350), 2017-2019 Chevy Silverado 1500, and 2017-2019 Dodge RAM 1500

- Mounts on the rear deck of sedans, to the rear headliner of SUVs, and pickup trucks
- 70 Scan-Lock flash patterns
- Eight, ten, or twelve lamp models for sedans
- Eight or ten lamp models for SUVs

 Solo prices start as low as **\$855.99**



### INNER EDGE® FST

SERIES LIGHTS

Inner Edge® FST™ WeCan®, SOLO™, DUO™ and TRIO™

The newly designed, low-profile Inner Edge FST Series better utilizes vehicle contours, providing higher visibility and a custom fit. Whelen's all-new patent-pending 100% silicone internal optics increase clarity and have the power to punch through tints.

- Available in Red, Blue, Amber, and/or White
- Fully programmable, available with SOLO, DUO, or TRIO interleaved light modules
- Vehicle specific housing minimizes flashback to vehicle passengers
- Available for both sides or passenger side only, mounts to visor anchor points
- 38 Scan-Lock™ flash patterns

 Solo prices start as low as **\$879.99**



### MIRROR BEAM™

SUPER-LED LIGHTHEADS

Custom molded Black housings fit over existing vehicle mirror glamour caps and feature high intensity Super-LED lighthoods. This placement provides unobstructed wide-angle warning and visibility.

- Ultra bright, lighting with low amp draw
- Multiple Scan-Lock™ flash patterns, standard.
- Rated for 100,000 hours of operation
- Available in red, blue, amber, white and split LED colors.

**MBDC11RB** Red/Blue Lighthoods, Dodge Charger, 2011-2019 | **\$395.00**

**MBFX11RB** Red/Blue Lighthoods, Ford Explorer, 2011-2019 and Police Interceptor Utility, 2013-2019 | **\$395.00**



### APPLICATION

Field replaceable ION™ lighthoods in custom molded left and right side housings that fit over the mirror.



# WHELEN®



IONJ model with standard clip mount on bottom.

## ION™ SERIES SUPER-LED® UNIVERSAL LIGHTHEADS

ION is a super-tough, water resistant ultra compact LED light, perfect for mounting anywhere on your vehicle, inside or out.

### STANDARD MODELS

ION\* | Red, blue, amber or white, black housing | **\$134.00**

IONW\* | Red, blue, amber or white, white housing | **\$134.00**

### SPLIT COLORS

IONJ | Red/blue, black housing | **\$140.00**

IONWJ | Red/blue, white housing | **\$140.00**

IOND | Red/white, black housing | **\$140.00**

IONWD | Red/white, white housing | **\$140.00**

IONM | Blue/amber, black housing | **\$140.00**

IONWM | Blue/amber, white housing | **\$140.00**



IONBKT2 model with optional rear hatch mounting bracket (shown with 3 ION's).



## ION™ V SERIES

IONV3\* Universal Mount ION with Combination 180° Warning, Take Down and Puddle Light Combination, Red, Blue, Amber or White Warning, Black Housing.

ION™ V-Series Super-LED® Universal Light | **\$271.00**



## ION™ T-SERIES SURFACE MOUNTED

The ION T-Series features Linear Super-LED® technology and a sleek and low profile design, with a depth of only 1/2" (13mm).

TLI\* ION T-Series | **\$135.00**



Lighthoods have been re-engineered with linear optics.

## ION TRIO™

- All new undercover, smoked lenses available
- Surface mount models include black flange
- 25 Scan-Lock flash patterns
- Five year warranty

## ION TRIO™ OPTIONS

I3JC | Red/Blue/White, with White Override, Black Housing | **\$193.00**

I3JA | Red/Blue/Amber, with Amber Override, Black Housing | **\$193.00**

I3KC | Red/Amber/White, with White Override, Black Housing | **\$193.00**

I3MC | Blue/Amber/White, with White Override, Black Housing | **\$193.00**

# WHELEN®



## AVENGER® II SERIES

Self-Contained Super-Led® Dash Lights

Single unit: 1 3/4" H x 4 1/2" D x 6 1/2" L; Dual unit: 1 3/4" H x 4 1/2" D x 10 1/4" L •

Height with adjustable mounting bracket for all models: 1 3/25" to 2 9/210" •

Five year warranty

### CIGAR PLUG DUO MODELS

AVC12# Single Lamp, Blue/Red, 26 flash patterns | **\$228.00**

AVC22DE Dual Lamp, 1 Red/White, 1 Blue/White, 55 flash | **\$387.00**

AVC22FF Dual Lamp, 2 Amber/White, 55 flash patterns | **\$387.00**

AVC22JJ Dual Lamp, 2 Red/Blue, 55 flash patterns | **\$387.00**

### CIGAR PLUG TRIO MODELS

AVC13RBC Single Lamp, Red/Blue/White, white override, 26 flash | **\$244.99**

### OPTIONS

AVBKT3D Visor mounting bracket for dual Avenger II Series | **\$29.00**

AVBKT4 Adjustable height bracket kit, for all Avenger II's | **\$47.00**

AVBKT5S Headliner bracket, adjustable, for single Avenger II's | **\$25.50**

AVBKT5D Headliner bracket, adjustable, for dual Avenger II's | **\$25.50**

# WHELEN®



VTXFB

VTXFC

VTX609

## VERTEX™ SUPER-LED CORNER LIGHT

Ultra small, self-contained, hemispheric LED light, for surface mount or internal mount within head-light, cornering lights and taillight assemblies. • 25 Scan-Lock™ flash patterns, includes synchronize feature • Available in Red, Amber, White and Blue and split colors. • Five year HDP® Heavy-Duty Professional warranty

VTX615 non split colors 15ft cable | **\$82.99**

VTX609 split color Red/blue 9ft cable | **\$118.00**

VTXFB face cover black | **\$9.00**

VTXFC face cover chrome | **\$18.00**

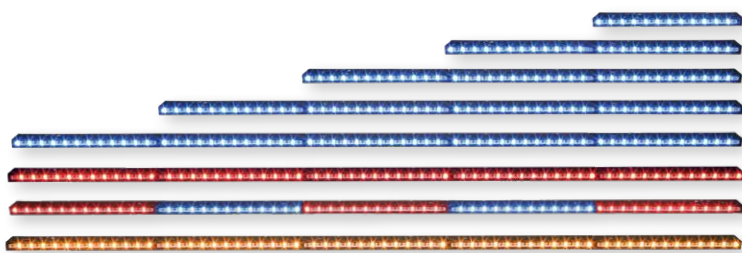

## TRACER™ SERIES, SUPER-LED® LIGHT ARRAY

The all new Tracer is designed from the ground up, utilizing Whelen's Super-LED technology to provide high intensity warning and illumination. Available in SOLO™, DUO™, or TRIO™ modules. 3D Scan-Lock™ flash patterns.

Size, single module:  
.75" (19mm) H x 1.75" (44.45mm) D x 12.5" (317.5mm) L

 Solo prices start  
as low as **\$1,579.00**

## FEDERAL SIGNAL



### CN SIGNALMASTER™

Features SpectraLux™ Multicolor LED Technology configurable in combinations of Amber, Blue, Red, or White • Compatible with FS Convergence Network sirens: PA300-CN and SmartSiren® Platinum • Available in 4-head or 8-head models • Built-in SignalMaster for rear facing models

### 8-HEAD FRONT MODELS WITHOUT INTERFACE MODULE

**CNSM8F-2653949** (4) Red LED reflectors, (4) Blue LED reflectors | **\$672.99**  
**CNSM8F-2653827** (6) Red/Blue LED reflectors, (2) Red/White/Blue LED reflectors | **\$887.99**

### 8-HEAD REAR MODELS WITHOUT INTERFACE MODULE

**CNSM8R-2654044** (8) Amber LED reflectors | **\$676.99**  
**CNSM8RS-AMBR4** (6) Amber LED reflectors, (2) White LED reflectors (work lights) | **\$859.99**  
**CNSM8R-RAB2** (6) Amber LED reflectors, (2) Red/Blue LED reflectors on ends | **\$676.99**  
**CNSM8R-2654797** (4) Red LED reflectors, (4) Blue LED reflectors | **\$676.99**

### 4-HEAD FRONT MODELS WITHOUT INTERFACE MODULE

**CNSM4F-2649516** (2) Red LED reflectors, (2) Blue LED reflectors (alternating) | **\$378.99**  
**CNSM4F-2649491** (4) Red/Blue LED reflectors | **\$454.99**  
**CNSM4F-2649434** (4) Red/White/Blue LED reflectors | **\$521.99**

### 4-HEAD REAR MODELS WITHOUT INTERFACE MODULE

**CNSM4R-2651544** (2) Red LED reflectors, (2) Blue LED reflectors (alternating) | **\$378.99**  
**CNSM4RS-CAT4** (4) Red/White/Blue LED reflectors | **\$521.99**  
**CNSM4R-2651620** (4) Red/Blue/Amber LED reflectors | **\$521.99**

## FEDERAL SIGNAL



**WIRING:**  
**RED** = + VDC for MEMORY 1  
**WHITE** = + VDC for MEMORY 2  
**BLACK** = + Chassis Ground  
**YELLOW** = Synchronization wire for connecting multiple light heads

### CORNER PERIMETER LED LIGHTS

- Single-color models have 12 LEDs
- Two-color models have 6 LEDs of each color (12 total)
- 19 flash patterns including "RANDOM" and "STEADY"
- Two programming modes: MEMORY 1 and MEMORY 2

**416910-\*** Single Color Corner LED | **\$91.99**

Colors: Amber, Blue, Red or White

**416900-\*\*** Dual Color Corner LED | **\$91.99**

## FEDERAL SIGNAL



**MICROPULSE BRACKETS:**  
**RED** = + VDC for MEMORY 1  
**WHITE** = + VDC for MEMORY 2  
**BLACK** = + Chassis Ground  
**YELLOW** = Synchronization wire for connecting multiple light heads

### MICROPULSE™ ULTRA EXTERNAL MOUNT/PERIMETER LIGHTS

- Superior warning with high-powered LEDs.
- Suitable for external and/or internal mounting applications.
- Single/multi-unit synchronization.
- Available in single, split, and dual color models.

**MPS300U-\*** 3-LED lighthead | **\$66.99**

**MPS600U-\*\*** 6-LED lighthead (pictured) | **\$89.99**

**MPS1200U-\*\*** 12-LED lighthead | **\$94.99**

# SoundOff Signal



## SoundOff Signal



### ULTRALITE GEN 3

Intense warning power provides a distinct safety advantage • Each module has 3 very bright, high bin Gen3 LEDs • Includes adjustable height universal "L"-brackets (pair) • for dash/deck or headliner mounts with 14" cable

#### EXTERIOR MODELS

**EL3D04A** | 13" 4 module | **\$297.99**  
**EL3D08A** | 26" 8 module | **\$509.99**  
**EL3D12A** | 39" 12 module | **\$676.99**

#### SUCTION CUP MOUNT

**EL3H02A0+(x)** | 7" 2 Module | **\$160.99**  
**EL3H04A0+(x)** | 13" 4 Module | **\$274.99**

#### INTERIOR MODELS

**EL3H04A00\*** | 13" 4 module | **\$264.99**  
**EL3H08A00\*** | 26" 8 module | **\$464.99**  
**EL3H12A00\*** | 39" 12 module | **\$614.99**

#### PERMANENT HEADLINER MOUNT

**EL3Z08A00(x)** | 26" 8 Module | **\$484.99**  
**EL3Z12A00(x)** | 36" 12 Module | **\$639.99**



### NFORCE® INTERIOR WINDSHIELD LED

Lower profile than competing lightbars for less windshield and personal obstruction • LED options: any combination of single color 6 or 9 LED, dual color 12 LED or tri-color 18 LED counts "All white" forward facing modules option for intense scene lighting • Flash Patterns: Warning-34; Arrow L/C/R-8 • Warranty: Five-Year

#### ENFWBFS (Two-Piece Model)

6-LED | **\$789.99**    12-LED Dual Color | **\$999.99**  
 9-LED | **\$874.99**    18-LED Tri Color | **\$1,137.99**

## SoundOff Signal



### NFORCE® SURFACE MOUNT LEDs

Single, Split, Dual and Tri-color capability • 6, 9, 12, and 18 LED counts • Steady-burn white capability • Separate color control capability • Secondary function can be either flashing or steady-burn

#### SPECS

- Flash patterns: 12 single color patterns, 14 Dual or 14 Tri-color
- Dimensions: 5.0" L x 1.72" H x 1.50" D
- Warranty: Five-year

**ENFSSS1(x)** | 6 LED, Solid or Split Colors | **\$119.99**

**ENFSSS2(x)** | 9 LED, Solid Colors | **\$131.99**

**ENFSSS3(x)** | 12 LED, Solid or Dual Colors | **\$138.99**

**ENFSSS4(xxx)** | 18 LED, Tri Colors-Blue/Red/Amber or Blue/Red/White | **\$157.99**



### GHOST™ WARNING LIGHTS

Single or Dual Light options available in single or split colors (each light may be a split color if desired) • Features 33 Flash Patterns • Optics designed for maximum, extreme angle output • 5 Year No Hassle Warranty.

**EGHST(x)** | Black Housing, Single Bracket | **\$117.99**

**EGHDT(xx)** | Black Housing, Dual light | **\$235.99**



## MPOWER® FASCIA 3"

Mpower® Fascia is the first extremely compact, tri-color line of perimeter lighting on the market. Fascia's next generation design and mounting options allows the light to be integrated nearly anywhere on the vehicle.

ClearDuty molded one-piece housing and optic design delivers advantages over conventional polycarbonate lenses • Dual and Tri-color capability • 12 single, 10 dual, 14 tricolor • 24 single sync, 2 lighthead



Grille mount application available. Please call us for more information.

### STUD MOUNTS

**EMPS1SLS1(x)** | 4 LED, Single Color | **\$83.99**

**EMPS1SLS3(x)** | 8 LED, Single or Dual Color | **\$121.99**

### QUICK MOUNTS

**EMPS1QMS1(x)** | 4 LED, Single Color | **\$83.99**

**EMPS1QMS3(x)** | 8 LED, Single or Dual Color | **\$122.99**

### SCREW MOUNTS

**EMPS1SMS1(x)** | 4 LED, Single Color | **\$4.99**

**EMPS1SMS3(x)** | 8 LED, Single or Dual Color | **\$122.99**



## LED3 MINI LIGHT

Features 33 built-in flash patterns with Light Sync Technology that allows you to synchronize up to 4 lights to flash alternating or simultaneously • Light includes Rubber Mounting Gasket, 18" of 3-wire shielded cable and Mounting Hardware for installation • 5 Year No Hassle Warranty

**EL3SN(x)** | LED3 Mini Light, 10 - 16 Vdc | **\$62.99**

### OPTIONAL MOUNTS

**EL3SNBRK190** | 90 Degree Bracket | **\$4.99**

**EL3SNBRK2LPH** | Horizontal License Plate Bracket | **\$12.99**

**EL3SNBRK2LPV** | Vertical License Plate Bracket | **\$12.99**



## SOUNDOFF SIGNAL® PLUG IN, SOLID STATE

Easy installation with plug-in connectors for police package models • Single flash pattern, Power Pulse • Built-in shutdown protection

**ETHFFUT-16** Ford Utility 16-19 | **\$119.99**



## SOUNDOFF SIGNAL® FLASHBACK TAILLIGHT FLASHER

12 wire module with isolating diodes for the brake and reverse • wire that are required for many new cars and trucks • Provides an additional output for deck lights • Alternating red and white light creates an effective rear warning signal.

**ETFBSSN-P** Solid State | **\$53.99**



## SOUNDOFF SIGNAL® SELECT A PATTERN

Ideal for most "big 3" car models • Select-a-Pattern Technology w/ 7 user selectable flash patterns: PowerPulse, RoadRunner, ETM, Cycle Flash, Q-Switch, Single Flash or Double Flash Alternating

**ETHFSS-SP** Solid Stat | **\$48.99**

**ETHFSS-SP-ISO** Isolated | **\$58.99**

## INTERSECTOR

Compact and bright, the light is designed to mount under the mirror, or can be surface mounted to any flat area • Made with 9 extremely bright Gen3 LEDs • Dual Color 18 LED option available! • Ships with 1-light, 1-gasket, 1-inline flasher, 3-angle wedges and 2-curved surface adaptors with mounting hardware for installatio • 5 Year No Hassle Warranty

**ENT2B3(x)** | Single Color | **\$178.99**

**ENT2B3(xx)** | Dual Color—Red/Blue | **\$207.99**





# WHELEN®

TRUSTED TO PERFORM™

## ARGES™ SUPER-LED®

360° REMOTE CONTROL SPOTLIGHT VISOR LIGHT

Proclera® Silicone Optics • Black die-cast aluminum housing • CenCom Core™ and WeCanX™ compatible • Provides 360° of continuous rotation and a 180° tilt range • The drivetrain is electronically and mechanically protected

**ARGES1** Arges 5 deg remote spotlight | **629.00**

**ARGES2** Arges ProFocus remote spotlight | **729.00**



1,800 lumens and 50% brighter than the Whelen PAR-46 replacement lamp

NEW

# HAVIS



## HAVIS® CHARGEGUARD SELECT

Self-contained unit provides circuit • protection for a vehicle's power system • Regulated by a programmable timer • Prevents dead batteries • LED indicates under and • over voltage conditions • Protects mobile electronics from voltage anomalies

CG-X | **\$91.99**



## HAVIS® IDLERIGHT 2

Vehicle Fuel Management System Control Module, New Gen

New generation Idle right system is designed to reduce engine wear, greatly extending the service life of vehicles • Ideal for vehicles that run light bars for extended periods of time while the vehicle is parked • System is designed to reduce fuel consumption, greatly reducing operation expenses up to 80%

IR-1002 | **\$133.99**



## PSI PROMAX

Automatic battery reconnect: convenient and safe • Easy to attach: 3 connections • Maximizes battery life: maintenance free • Handles 1,000 starting amps • Designed for under-hood environment • Engine run and hazard light protection • Universal design fits both top & side-post batteries • Ability to use accessories when engine is off

Priority Start ProMax | **\$118.99**

# SECURE-IDLE

maximum control, elite protection



## SECURE-IDLE ANTI-THEFT SYSTEM

Concealed anti-theft patented technology • Engine runs secure with no key in ignition • Proprietary starter override protection • Quick and east installation

**340TK** for '06 and up Impala | **\$165.99**

**340TK06** for '06 and up Tahoe | **\$165.99**

**340EH07** for '07 and up Expedition | **\$189.99**

**240TIH** for '13 and up Interceptor Sedan & Utility | **\$189.99**

**440CVTH05** for '05 and up Crown Victoria/harness plug | **\$189.99**

## PIONEER SCENELIGHTS

Compact size scenelights ideal for challenging applications. Rugged, die-cast aluminum housing, powder coated Black or White.

### MICRO PIONEER SERIES



MPBB  
**\$421.00**

MPBW  
**\$421.00**

MPR15B  
**\$516.00**

MPRW  
**\$516.00**

### PIONEER NANO SERIES

Three and Six Diode Work/Scene Lights



NP3BW  
**\$208.00**

NP6BW  
**\$260.00**



X335-0002

X335

## X335 SERIES X-LED 6"

Post-Mount Spotlights (Model S14)

The X335 series post-mount style spotlights feature a 6" LED composite lamp rated at 225,000 candlepower, 12 volts, 30 watts and 50,000 hours of lamp life. Meets SAE J591 Spotlamp Standard.

Prices start as low as | **\$319.99**



Call for model information and pricing.



## UNITY® VEHICLE MOUNT SPOTLIGHTS



Head rotates 360° horizontally and 120° vertically • Specify year, make and model of vehicle and either DRIVER or PASSENGER side mounting when ordering

Model 330: 245,000 candlepower, 100W, with 100 hr lamp life.  
Model 325: 160,000 candlepower, 50W, with 100 hr lamp life

Prices start as low as | **\$145.99**

Brackets as low as | **\$34.99**

Handle Assembly U-6701 | **\$34.99**

Halogen Spotlight Assembly U-7682 | **\$31.99**

**VEHICLE CONSOLES**



**WIDE BODY CONSOLE**

20" Mounting Space, Side Storage with locking lid (opens sideways towards P/S seat) (1) Magnetic Mic System, Divers Side knockout for mounting speaker, passenger side fuse block with cover/access panel.

**425-6445** | 20", Use with Floor Plate Kit. | **\$554.99**



**FORD F-150 CONSOLE**

The Ford F-150 SSV/Police Responder (2018+) Contour Console has a dash contouring shape and will mount up to 20" of equipment. Simply replace the factory console in minutes using top-down installation. No drilling required.

**425-6500** | Ford F-150 (2018+) Contour Console with Locking Lid Storage | **\$696.99**



**WIDE BODY CONSOLE**

A unique feature of console design is that allows for an integration of a Pentax/Brother PocketJet 6/7 Printer and paper roll for easy access for the officer. Installation is quick and easy. No drilling required.

**425-6644** Charger 16+ 16" of Mounting Space | **\$460.99**

**425-6621** Tahoe 15+ with Locking Lid and 14" of Mounting Space | **\$665.99**

**425-6482** Universal Wide Body IPB Console with 11" of Mounting Space | **\$418.99**



**FORD POLICE INTERCEPTOR (2020+) CONTOUR CONSOLE**

This console (425-3704) is shown with optional accessories. The console also comes predrilled with mounting locations for the Side Laptop Mount—425-5699.

**425-6505** 2020+ Utility Console | **\$382.99**

**425-3704** Cupholder | **\$46.99**

**425-6411** Adjustable Armrest | **\$102.99**

**425-5699/5215** Side Laptop Mount | **\$337.99**

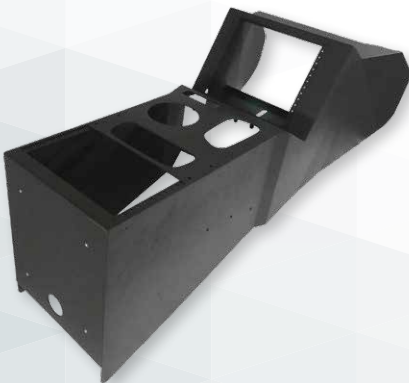

**DODGE DURANGO 2019+ CONSOLE**

The Contour Console for the Dodge Durango PPV (2019+) is designed to mount 12 inches (7" top and 5" bottom) of radio and communications equipment in vehicle.

**425-6655** Dodge Durango PPV (2019+) 12" Contour Console | **\$464.99**



**DODGE CHARGER (2012+) HORIZONTAL CONTOUR CONSOLE**

Horizontal law enforcement equipment console designed to mount 14 inches of radio and communications equipment in public safety vehicles. The sleek design allows console to be mounted from dash to between seats.

**425-6675** Horizontal Contour Console | **\$371.99**



## JOTTO DESK®



NORMAL LAPTOP MOUNT

HEAVY LAPTOP MOUNT

### COMPUTER SIDE MOUNTS

The Jotto Desk® Console Side Mount features No Holes Drilled installation on the side of a compatible equipment console, this laptop desk offers a straight arm which enables you to pull the desktop over for comfortable operation.

### NORMAL LAPTOP MOUNTS

The Laptop Tray will rotate 360 at the end of the straight arm enabling you to easily fine tune screen viewing.

**425-5010/4143** or 4144 | Ford Police Interceptor Utility 2020+ | **\$576.99**

**425-5640/4143** or 4144 | Dodge Charger 2011+ | **\$576.99**

**425-5600/4143** or 4144 | Dodge Durango 2011+ | **\$576.99**

**425-5596/4143** or 4144 | Tahoe/Silverado 15+ | **\$576.99**

### HEAVY DUTY COMPUTER MOUNTS

**425-5630/4138** or 4138 | 2015+ Dodge Charger | **\$829.99**

**425-5032/4138** or 4138 | 2020+ Ford PI Utility | **\$829.99**

**425-5646/4138** or 4139 | 2015+ Tahoe | **\$829.99**

**425-5107/4138** or 4138 | 2015 + Dodge Ram PPV | **\$829.99**

**425-5104/4138** or 4139 | 2015+ Ford F-150 | **\$829.99**

Please call for model information and pricing.



### ABS DUAL CUPHOLDER FACEPLATE MOUNT

Holds 2 drinks and mounts to faceplate rails of equipment console.

425-3704 | **\$46.99**



### SIDE HINGED ARMREST

**425-3841** | IPBCC for Charger 13+ / PI Utility 13+ / PI Sedan 13+ | **\$155.99**



### DUAL CUPHOLDER EXTERNAL MOUNT

Mounts to the floor plate. Holds mugs, cans and larger size drinks.

425-6205 | **\$48.99**



### ADJUSTABLE ARMREST FLOOR PLATE MOUNT

New design includes more height adjustment and increased strength. Height adjusts from 11" to 14.5".

425-6411 | **\$102.99**



### 4" FACEPLATE LOCK BOX

Provides storage space in equipment console. Dimensions: 3.75"L x 7.3125"W x 2.625"D

**425-4026** | 4" Faceplate Lock Boxan 13+ | **\$129.99**



### TRUNK TRAYS

Help prevent damage to the vehicle and the equipment when a vehicle is in motion. Utilizes a dual locking assembly locking tray in closed position.

**425-8105** Ford Interceptor Sedan (2013+) | **\$451.99**

**425-8103** Dodge Charger (2011+) | **\$451.99**

## JOTTO DESK®



- (A) Fuse panel for easy wiring
- (B) Knockout for speaker relocation
- (C) Relocate OEM 110V outlet
- (D) Relocate USB/SD connector

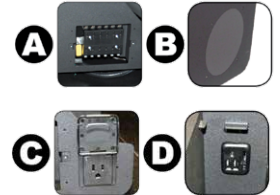

### CHEVY TAHOE

#### CONTOUR CONSOLE LOCKING LID STORAGE (2015+)

This Law Enforcement equipment console is designed to mount 20 inches of radio and communications equipment in public safety vehicles. The 2015+ Chevy Tahoe Contour Console with locking lid storage mounts 20" of equipment.

**425-6268** Console Locking Lid | **\$665.99**

- Pre-drilled faceplate screw holes
- Wide footprint to fill gap between seats
- Storage compartment with locking lid
- 1 magnetic mic
- Designed for computer side mount
- Designed for armrest

## JOTTO DESK®



### USB & POWER OUTLET FACEPLATE

**425-6164** | USB x 2 & 12V Power Outlets x2 in 2" Faceplate | **\$84.99**



### MAGNETIC MIC

Enhances safety by reducing distracted driving • Design to work with all major microphone manufactures • Easy to retrofit the standard, two-hole mount • Works with scan mode

MMSU-1 | **\$34.99**



# VEHICLE CONSOLES AND ACCESSORIES



MCS-EPIC13-W/O



MCS-EPIC17-W/O



7160-0085



7160-0100

## GAMBER JOHNSON® MCS

Gamber Johnson's Mission Control System (MCS) allows you to mix and match to create your ideal solution. To start, select your specific vehicle MCS Leg Kit. Next determine what equipment you are planning on mounting to select the correct top plate and console box. Gamber Johnson's top plates are wider in design to allow you three different computer mounting positions (towards driver, centered, towards passenger).

**MCS-EPIC13-W/O** 13" Console Box, 12 knockout panels | **\$297.99**

**MCS-EPIC17-W/O** 17" Console Box, 12 knockout panels | **\$336.99**

**7160-0085** 29" Long Top Plate | **\$90.99**

**7160-0121** Impala Leg Kit | **\$117.99**

**7160-0160** Chevy/GMC SUV Leg Kit | **\$155.99**

**7160-0413** Ford Sedan and Utility (2013-2019) Leg Kit | **\$95.99**

**7160-0084** Ford Expedition Leg Kit | **\$138.99**

**7160-0088** Charger Leg Kit | **\$101.99**

## MCS ACCESSORIES

**MCS-ARMREST** Heavy Duty Padded Armrest | **\$174.99**

**7160-0006** Pentax Printer Armrest | **\$370.99**

**MCS-CUPHOLD2** Universal Double Cup Holder | **\$39.00**

**MCS-EPICMIC** Rail-Mounted Microphone Clip | **\$39.99**

**MCS-MICPLT** Microphone Clip Face Plate | **\$48.99**

**MCS-POCKET3** Interior Pocket | **\$71.99**

**7160-0100** Side-Mounted LED Task Light | **\$175.99**

**7160-0110** Power Distribution Block | **\$55.99**

**7160-0063** Cigarette Lighter Adapter Kit | **\$25.99**

**3130-0361** Cigarette Knockout Filler Panel | **\$13.99**



## GAMBER JOHNSON®

### CHEVY TAHOE CONSOLES (2015+)

No-drill vehicle specific console • Leg kit is provided with the console box • Vertical, angled section designed to house two full sized radios • Traction Control can be relocated to the top of the console box with the included bracket • Two 12 volt plug inserts (on passenger side), one 12 volt cigarette adapter kit included

**7170-0237-01** Chevy Tahoe Console (2015+) with cupholder and armrest | **\$644.99**



Call for other model information and pricing.

## GAMBER JOHNSON®

### DODGE CHARGER CONSOLES (2011+)

Shorter console box allows for more room when mounting weapons on the prisoner cage • Vertical, angled section accommodates 6" of mounting space and is designed to house full sized radios • USB and MP3 knock-outs from stock console, relocated on passenger side

**7160-0353** Dodge Charger Console (2011+) | **\$375.99**

**7160-0354** Dodge Charger Console (2011+) with cupholder and armrest



7160-0410

7170-0734-01

Low profile no-drill vehicle specific console • Vertical angled section accommodates 6" of mounting space • Horizontal low profile section accommodates 11.5" of mounting space (with internal Cup holder 7.0" of mounting space) • 12 volt plug insert (located on passenger side) • Will ship fully assembled • Includes blank filler panels and faceplates

## GAMBER JOHNSON®

### FORD INTERCEPTOR CONSOLES (2012+)

**7160-0410** Ford Sedan Console (2012+) | **\$357.99**

**7170-0165-01** Ford Sedan Console (2012+) w/ cupholder and armrest | **\$588.99**

**7170-0734-00** Ford Utility Console (2012+) | **\$425.99**

**7170-0734-01** Ford Utility Console (2020+) w/ cupholder and armrest | **\$594.99**



## PANASONIC CF-33

### TABLET DOCKING STATION

This docking station comes fully loaded with all the ports your drivers will need including VGA, HDMI, serial 9 pin, and USB.

**7160-0907-00** Docking Station for Panasonic CF-33 | **\$1,213.99**

We offer many more Gamber Johnson Laptop and Tablet docking stations. Please call us for more info!

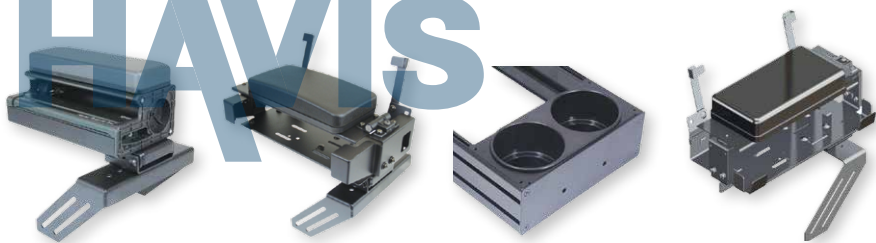

- #C-ARPB-101
- #C-ARPB-107
- #C-CUP2-1
- #C-ARPB-104

**HAVIS® CONSOLE AND LAPTOP/TABLET ACCESSORIES**

**MCB** Mic Clip Bracket (mounts to side of console) | **\$13.99**

**MC** Mic Clip (keeps mic easy to reach and clip) | **\$10.99**

**C-MCB-CV** Dual Mic Clip Bracket | **\$19.00**

**C-ARM-101** Top Mount Armrest | **\$75.99**

**C-ARM-102** Side Mount Armrest | **\$66.99**

**C-ARM-103** Top Mount Large Pad Flip Up Armrest | **\$113.99**

**C-ARPB-101** Top Mount Armrest with PocketJet Printer Bracket | **\$278.99**

**C-ARPB-104** Top Mount Armrest with HP450/460/470 Printer Bracket | **\$278.99**

**C-ARPB-107** Top Mount Armrest with PCanon IP100 Printer Bracket | **\$278.99**

**C-CUP2-1** Internal Cupholder (4" high plate, mounts flush) | **\$40.99**

**C-LP-2** Two 12V DC Lighter Plug Outlets (with caps) | **\$34.99**



The Universal Tablet Mount is compatible with most 10-inch tablets including Acer, Apple, Asus, Dell, Lenovo, Motorola, Panasonic, Samsung and Toshiba.

**UT-2001** Universal Mount | **\$251.99**

**BASE PACKAGES**

We offer many other Havis armrest models and other accessories not shown here. Call for info and pricing.

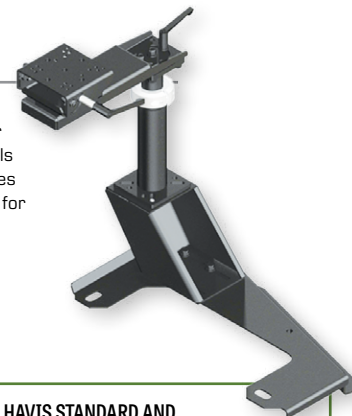

**DON'T FORGET YOUR HAVIS STANDARD AND PREMIUM MOUNTING BASE PACKAGES WHEN ORDERING YOUR LAPTOP/TABLET DOCKING STATIONS. PLEASE CALL US FOR AVAILABLE MODEL OPTIONS.**

**HAVIS UNIVERSAL LAPTOP/TABLET CRADLES**

Easy to use and customize to fit your computing needs • rounded corners and edges are ideal for your safety in accidents and airbag deployment, in addition to daily use and operation of universal laptop mount. • Lock and key supplied for peace of mind theft deterrence

**UT-1001** Laptop Cradle | **\$279.99**



**HAVIS®**

**VEHICLE SPECIFIC CONSOLES**

Save installation time by attaching directly to existing OEM console. Easy to install by attaching directly to your OEM console which provides a sleek appearance and a precise fit. No permanent modification is needed which saves on installation time. All consoles include equipment brackets and filler plates to enclose top of console.

**C-VS-2000-TAH-2** 20" Console for 2015 and up Chevy Tahoe | **\$563.99**

**C-VS-1200-EXPD1** 12" Console for 2007 and up Ford Expedition | **\$246.99**

**C-VS-1308-INUT** 21" Console for 2013 and up Ford Interceptor Utility | **\$386.99**

**C-VS-1400-INSE** 14" Console for 2013 and up Ford Interceptor Sedan | **\$266.99**

**C-VS-1012-INUT** 22" Console for 2020 and up Ford Utility | **\$451.99**

**C-VS-1508-INSE** 23" Console for 2013 and up Ford Interceptor Sedan | **\$420.99**

**C-VS-1600-EXPL-3** 16" Console for 2019 and up Ford Explorer | **\$387.99**

**C-VS-2400-CHGR-2** 24" Console for 2011 and up Dodge Charger | **\$353.99**

**C-VS-0618-INUT** 24" Console for 2020 and up Ford Interceptor Utility | **\$451.00**



— Must specify equipment when ordering. Call for other model information and pricing.



**FORD INTERCEPTOR UTILITY 2020 22"**



**FORD INTERCEPTOR UTILITY 2020 24" FLAT CONSOLE**



**FORD EXPLORER 2019+ 16"**

# SETINA®

## PUSH BUMPERS AND DOOR PROTECTION

### SETINA®

#### HORIZONTAL SLIDING PARTITIONS

- Provides strength, entry and exit space through passenger side rear door
- Available with Horizontal Sliding and Stationary window options
- Recessed weapon Storage Panel between front seats as shown also available

Specify make, model and year of vehicle when ordering.

**PK1140\*\*\*** 7-XL—Stationary Window with Wire Mesh Screen | **\$798.99**

**PK1134\*\*\*** 8-XL-L—Half Lexan and Half Wire Mesh Screen | **\$818.99**

**PK1130\*\*\*** 10-XL—Horizontal/Sliding Recessed & Extension Panel included | **\$878.99**



PK1140



PK1134



PK1130



#### XL-PARTITION:

Suspended mounting design has Recess Panel and Extension panel included (Weapon mounts sold separately)

### SETINA®

#### WINDOW BARRIERS AND DOOR PANELS

##### STEEL WINDOW BARRIERS

- Unique design prevents window from being kicked out
- Removable for cleaning, scratch resistant black powder coated finish
- Works with after market or original door panel

##### POLYCARBONATE WINDOW BARRIERS

- Coated Polycarbonate is guaranteed for a period of seven years against scratching, UV damage and breakage under normal use

##### POLYCARBONATE DOOR GUARDS

- Door Guard installs right over the existing door panel and conceals all fasteners in the door sills making it extremely tamper resistant



##### WINDOW BARRIERS

**WK0513\*\*\***

Sedan Steel **\$248.99**

**WK0594\*\*\***

Sedan Poly **\$268.99**



##### WINDOW BARRIERS

**WK0514\*\*\***

SUV Steel **\$268.99**

**WK0595\*\*\***

SUV Poly **\$288.99**



##### DOOR PANELS

**DK0100\*\*\***

Sedans & SUVs **\$268.99**



Please call us for options and pricing on other vehicles.



## SETINA® BODY GUARD

- Integrated Front LED Warning Lights are available
- Optional side mounted lights for maximum intersection visibility
- Available with optional fender protector wraps

**BK0532\*\*\*** Model PB400A—Non-Lighted - Sedans | **\$358.99**

**BK0534\*\*\*** Model PB400SUV-A-F—Non-Lighted - Trucks & SUVs | **\$398.99**

**BK2017\*\*\*** Model PB450LVS-2—Two LEDs - Vans, Trucks, SUVs | **\$758.99**

**BK2019\*\*\*** Model PB450LVS-4—Four LEDs - Vans, Trucks, SUVs | **\$918.99**

**BK2005\*\*\*** Model PB450LS-2—Two LEDs - Sedans | **\$708.99**

**BK2007\*\*\*** Model PB450LS-4—Four LEDs - Sedans | **\$887.99**



Fender protectors have replaceable Mar-Resistant rubber push pads.

## HAVIS®

### PRISONER TRANSPORT SYSTEMS

Interior dome lights to help visibility before opening doors • Rear/side loading steps and optional rear load light to help with loading and unloading • Grab straps, non-slip flooring, emergency exits, and the "Slam Latch" designed to help protect both you and prisoner • Available third compartment keeps prisoners separated and eliminates multiple trips • 7 Heavy gauge aluminum walls and benches • All white powder coat finish improves appearance and visibility in compartments.

PRICES START AS LOW AS \$8649.99

Call us with your vehicle information and we'll gladly give you ideas on your containment needs.



#### CONFIGURATION EXAMPLES:

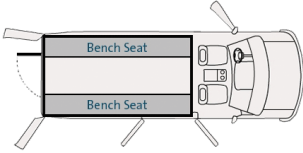

SINGLE COMPARTMENT

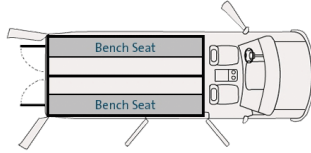

DOUBLE COMPARTMENT

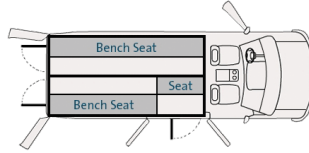

TRIPLE COMPARTMENT

## SETINA®

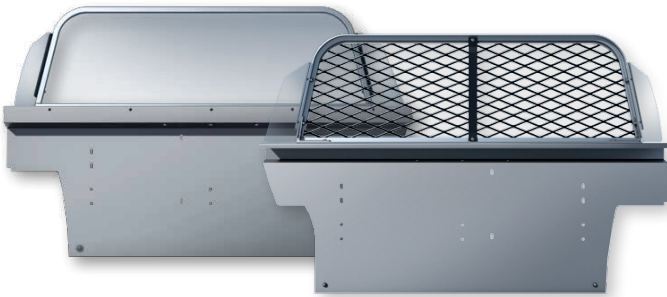

### MODEL 12

#### REAR COMPARTMENT PARTITION

Designed for enclosing cargo area behind rear seats of Explorers, Cherokees, Suburbans, Blazers, Broncos and Tahoes. • Made of 11-gauge, vinyl-coated, expanded metal screen with 1.5" x .75" diamond openings • Aluminum window framework • 14-gauge steel seat back protector panel

PK0123\*\*\* 12-VS-P—Wire Mesh | \$448.99

PK0316\*\*\* 12-VS-L—Lexan (pictured) | \$478.99

*Specify make, model and year of vehicle when ordering.*

## JOTTO DESK®



#475-0861

#475-0861

## JOTTO DESK®

#### WINDOW ARMOR

Helps to reduce the likelihood of damage and escape from prisoner transport. The armor is made from solid Cold Rolled Round Steel, making it more durable than ever before!

475-0228 Dodge Charger 2011+ | \$193.99

475-0848 Ford Interceptor Utility 2020+ | \$315.99

475-0861 Chevy Tahoe 2015+ | \$277.99

475-0229 Dodge Charger 2011+ & door panel package | \$386.99



Please call us for options and pricing on other vehicles.



## VIPER™

#### SHIELD ENHANCED SPACE SAVER PARTITIONS

Includes: Recessed Panel, Lower Extension Panels, VIPER™ Shield • Patented Airbag Compatible Wings • Heavy-duty construction easily withstands aggressive prisoner assaults • Portable Ballistic Protection • 9 Window Configurations Available • Optional Vertical, Horizontal, or Compact Mount Weapon Racks • Compatible with our AOITM Side Curtain Airbag On/Off Control Switch

PVS4704UINT20A Center Sliding Poly Window | \$3,934.00

PVS4714UINT20A Poly Center Slider Window with Expanded Metal Insert | \$3,934.00



## PRO-GARD™

#### FORD PUSH BUMPERS

Integrated LED Lightbars are available in three lighting patterns: all red, all blue, or ½ red and ½ blue • Integrated mounting design will not interfere with the SRS airbag system • Pre-cut holes and slots in the bumper allow for mounting popular auxiliary lighting and speakers • Black powder coated finish prevents corrosion from salt spray and other environmental conditions

#### FORD SEDANS

PB36INT13 | \$302.00

PB36INT13ION2RB | \$811.00

PB36INT13LEDRB | \$995.00

#### FORD UTILITY

PB47UINT20 | \$355.00

PB47UINT20ION2RB | \$858.00

PB47UINT20LEDRB | \$1083.00



Please call us for options and pricing on other vehicles.



# TRUNK BOXES AND TRAYS

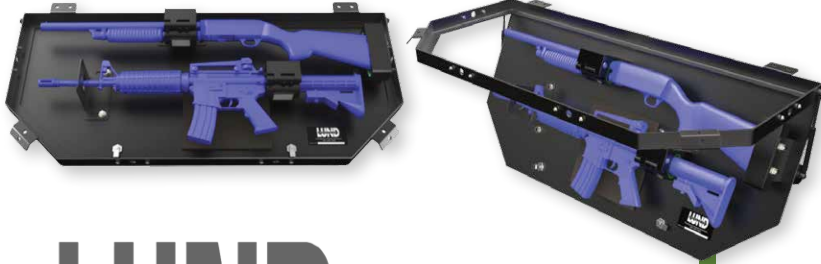

# LUND INDUSTRIES

## THE LOFT DUAL GUN VAULT

THE LOFT fits up near the headliner, up and out of your line of sight through the rear-view mirror providing secured gun storage. Provides easy installation of side and rear facing emergency LEDs with optional mounting kit.

- LOFT-PIU20-EC** for electronics for 2020+ ford utility | **\$612.85**
- LOFT-PIU20-6V** with single gun lock for 2020+ ford utility | **\$635.00**
- LOFT-PIU20-2G** with 2 gun locks for 2020+ ford utility | **\$825.00**

Interior dimensions:  
16.5" x 40".



## OPTIONAL ACCESSORIES

Included are 2 Gun Locks, Muzzle Bracket Assembly, Butt Cup & Momentary Push Button Switch and is designed for use with an 18" Shotgun & M4.

- LOFT-TAH16-EC** for electronics for 2015+ tahoe | **\$612.85**
- LOFT-TAH16-6V** with single gun lock for 2013+ ford utility | **\$635.00**
- LOFT-TAH16-2G** with 2 gun locks for 2013+ ford utility | **\$825.00**

## SETINA®

### HEAVY DUTY CARGO TRAYS

Universal Design for SUV's — The top box is lockable for firearms and other important accessory storage. The bottom slide out tray is designed with 300 lb capacity, lock in and lock out Accuride slides, and is deeper to accommodate most radio and other heavy accessory equipment.

- Standard**—With Combination lock
- Optional**—Key lock also available

 Solo prices start as low as **\$939.00**



## SETINA®



## PRO-GARD®

### SUV CARGO SECURITY COVER

Pro-gard's Cargo Security Cover conceals equipment, weapons, tools, electronics, gun racks and any necessary officer gear that is kept in the cargo area.

- CSC47UINT20** Ford Interceptor Utility | **\$489.99**
- CSC57T15** Chevy Tahoe | **\$510.00**



## TUFLOC®

### TUFBOX™

TufBox™ is a locking drawer system that provides a way to secure weapons, store equipment and organize belongings to keep them safe and out of the way. TufBox™ is manufactured with a heavy-duty, metal framework and 12-gauge, steel sides.

- 36-009** Large SUV, 12" H x 48" W x 32" Depth | **\$1,088.99**
- 36-010** Small SUV, 12" H x 38" W x 32" Depth | **\$1,039.99**
- 36-300** Mount Base, 8" H x 43.5" W x 20" Depth | **\$296.99**

**Pro-gard**  
PRODUCTS LLC.

**TUFLOC**





**HAND GUN BOX**

**GUN MOUNT**

## TRI-LOCK WEAPON MOUNTING SYSTEMS

### FEATURES OF THE TRI-LOCK WEAPON MOUNTING SYSTEM

Available in Vertical Partition Mount and Self-Supporting Mount with room for up to three weapons: one handgun and two long guns • Weapon mounting location is adjustable • Momentary switch with 8 second delay timer • Choose from three different key styles: Handcuff, Straight, or Vending

### FEATURES OF THE SELF-SUPPORTING MOUNT VERSIONS

- For vehicles without partitions
- Fits comfortably behind most aftermarket consoles
- Guns line up with seat edge for easy access that won't interfere with driver's range of motion

### FEATURES OF THE PARTITION MOUNT VERSIONS

- Fits on Pro-gard's Space Saver and Space Saver Plus Partitions (with recessed panel)

Partition Mount Models starting at **\$519.00**

Self-Supporting Mount Models starting at **\$545.00**



**BLAC-RAC**



**UNIVERSAL**



**SMALL**



**LARGE**

## SETINA®

### WEAPON MOUNTING SYSTEMS

Interchangeable Locks • Partition Mount—Available in Double or Single Mount models. Fits XL, Recessed Panel and Flat Panel Partitions. • Free Standing Mount—The versatile Free Standing Weapon System offers you complete flexibility.

Single gun racks starting at **\$273.99**

Dual gun racks starting at **\$389.99**

All free standing mounts **185.9** (plus gun rack)



### AVAILABLE IN THESE CONFIGURATIONS:

- Vertical Partition Mounted
- Horizontal Partition Mounted
- Rear Seat Mounted
- Single Cell Mounted
- Trunk Mounted
- Rear Hatch Mounted

## JOTTO DESK®

### ZRT GUN RACK AND LOCK HEAD

The ZRT Gun Rack is designed to be "field adjustable" by the officer. Simply loosen a ratchet handle and raise or lower the brackets within a defined area. This allows multiple weapons with various stocks to fit into one gun rack.

**475-2010** Dual Gun Rack, Vertical Mount | **\$483.99**

**475-2014** Single 870 Gun Rack | **\$349.99**

**475-2015** Single AR Gun Rack | **\$373.99**



## HAVIS®

### K9 TRANSPORT SYSTEMS

Easy to install and ride rattle free • Hinged window guards provide easy access for window cleaning • Front sliding door for easy access • to drivers compartment • Interior dome light for better visibility

**K9-F28** 2020 and up, Ford Interceptor Utility | **\$2,499.99**

**K9-C23** 2015 and up, Chevy Tahoe | **\$2,356.99**

**K9-A-201** K9 Hot 'n' Pop System | **\$2,092.99**

**K9-A-103** Built in Water Bowl Option | **\$61.99**



## E/Z RIDER

### PRISONER & K9 KITS

A safe, convenient solution for dual K9/Prisoner transport needs. The E/Z Rider 1/3rd Prisoner, 2/3rds K9 Unit is designed to carry a prisoner in a confined space for a short period of time, with the Officer and the K9 Officer's protection and safety foremost in mind.

E/Z-1/3 Prisoner-2/3 K-9 Kit

| K9 and Prisoner Kit | **\$2,829.99**

E/Z Rider Platform

| K9 Platform Only | **\$2,359.99**





**KUSTOM SIGNALS, INC.®**

**LIDAR AND RADAR SYSTEMS**



**PROLASER® 4**

**LIDAR SPEED MEASUREMENT**

Faster target acquisition • Greater range: 10 to 8,000 feet • Smaller, lighter profile: only 2.5 lbs. • Simple user interface; one touch controls • High contrast OLED graphical display • Speed and range in HUD • Event Record in internal memory • Eight (8) AA rechargeable batteries and charger included

Prices start as low as **\$2,500.00**



**RAPTOR RP-1™**

**WEATHER-PROOF, DASH MOUNTED RADAR**

- Directional K and Ka band radar
- DuraTrak™ Target Tracking
- TruTrak™ with Automatic Mode Switching
- LCD display makes Raptor easy to use, day or night
- Waterproof display and antennas
- Online operator training

Prices start as low as **\$1,250.00**



**FALCON® HR**

**DIRECTIONAL K-BAND RADAR**

Hand-held or dash mount options allow for flexible operation. • Simple interface with LCD graphics • Ability to track multiple targets • Available in hand-held or as a dash mounted device. • High Performance, Low Power • Longer battery operating times

Prices start as low as **\$700.00**

**MOUNTING KITS**

The Raptor RP-1 can be fitted in a wide variety of locations and a series of mounting kits has been especially developed for law enforcement vehicles.



FRONT TARGETS



FRONT TARGETS



REAR TARGETS



REAR TARGETS

**THREE COLOR DISPLAY**

**TWO COLOR DISPLAY**  
(IDEAL FOR NIGHT TIME USE)

**EAGLE 3**

**REVOLUTIONARY RADAR SYSTEM**

The color touch screen display changes color with front and rear target tracking. The user selectable options include one, two, three and five color options. The radar can be completely controlled with the touch screen and doesn't require the remote to be operational.

Front and Rear Scan Mode for advanced target tracking • Faster processing provides greater targeting range and improved target acquisition • Wireless Vehicle Speed Sensing enables automatic mode switching and independent patrol speed verification • Automated fork test method with mandatory option simplifies testing procedures.

Prices start as low as **\$1,250.00**



### SMART@ 650

#### RADAR SPEED TRAILER

Designed for maximum visibility (up to 750 feet) • 12" (30.5 cm) full matrix, high intensity LED display • Flashing overspeed violator alerts • MUTCD compliant speed sign • Interchangeable speed sign numbers from 5 to 45 mph

☎ Prices start as low as **\$5,400.00**  
Please call us for more information.



### SMART@ 500/510

#### DIRECTIONAL RADAR SPEED DOLLIES

"SCHOOL ZONE" or "YOUR SPEED" sign • The SMART 500 has more rugged, heavier construction • SMART 510 is lightweight, collapsible and easy to transport

☎ Prices start as low as **\$2,400.00**



**WSDT3-SPD**  
RADAR-SPEED TRAILER  
Prices start as low as **\$7,800.00**



**WVTMM-PD**  
METRO™ MATRIX SIGN  
Prices start as low as **\$14,000.00**



**WVTM-PD**  
MINI MATRIX SIGN  
Prices start as low as **\$16,950.00**



**WVT3-PD**  
MINI THREE-LINE SIGN  
Prices start as low as **\$16,300.00**



**WVTM-5C-PD**  
5-COLOR MATRIX  
Prices start as low as **\$29,500.00**



### ROADHOUND™

#### DRIVING ALERT & DETERRENT ROAD SIGN

An electronic roadside alert and trailer combination that automatically detects and deters distracted drivers on the road. This distracted driving alert is a fully self-contained DOT certified.

- Phone detection receiver
- Linear antenna array
- Vehicle radar and solar charged battery power.

☎ Please call us for availability and pricing on other models.



## LEONARDO

### ELSAG

#### MOBILE PLATE HUNTER M6™

Digital ELSAG ALPR cameras read license plates, day or night, in any weather. • Mobile systems process plates on parked and moving vehicles. • Plates are processed at up to 150 mph (241 kph) closing and passing speeds. • Captured data includes date/time stamps, GPS coordinates and photo of the license plate. • Fixed systems can capture the speed of passing vehicles.

☎ Call for pricing and packages available

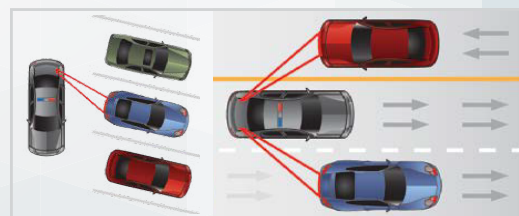



## PAC-KITS® WEATHERPROOF FIRST AID KITS



50 Person Kits and Steel Case Kits are available. Please call us for more info!

### 10 PERSON

#### BULK PLASTIC, ANSI A RATED

This compact, 10 person, first aid kit is ideal for home, car or for a small office. The plastic weatherproof case keeps contents safe from dust and moisture.



#### INCLUDES

- |      |                                    |     |   |
|------|------------------------------------|-----|---|
| (16) | Plastic Bandages, 1" x 3"          | (6) | Hand Sanitizer Packets, 0.9g              |
| (1)  | First Aid Tape, 1/2" x 5yd         | (4) | Nitrile Exam Gloves                       |
| (10) | Triple Antibiotic Ointment         | (1) | Conforming Gauze Roll, 2"                 |
|      | Packets                            | (1) | Scissors                                  |
| (10) | BZK Antiseptic Towelettes          | (2) | Gauze Dressing Pads, 3" x 3"              |
| (1)  | CPR Mask with One Way Valve        | (2) | Trauma Pads, 5" x 9"                      |
| (1)  | Burn Dressing, 4" x 4"             | (1) | Triangular Sling/Bandage, 40" x 40" x 56" |
| (10) | First Aid/Burn Cream Packets, 0.9g | (1) | First Aid Guide                           |
| (1)  | Cold Compress, 4" x 5"             |     |   |
| (2)  | Sterile Eye Pads                   |     |   |
| (1)  | Eyewash, 1oz                       |     |   |



90754 10 Person, Plastic First-Aid Kit | \$22.99

### 25 PERSON

#### BULK PLASTIC, ANSI A RATED

This 89-piece, 25-person bulk first aid kit meets OSHA and ANSI standards, and is designed for use in small offices, vehicles and work sites. The weatherproof plastic case is wall-mountable, yet has a handle for easy carrying.



#### INCLUDES

- |      |                                    |     |   |
|------|------------------------------------|-----|---|
| (32) | Plastic Bandages, 1" x 3"          | (6) | Hand Sanitizer Packets, 0.9g              |
| (1)  | First Aid Tape, 1/2" x 5yd         | (4) | Nitrile Exam Gloves                       |
| (10) | Triple Antibiotic Ointment         | (1) | Conforming Gauze Roll, 2"                 |
|      | Packets                            | (1) | Scissors                                  |
| (10) | BZK Antiseptic Towelettes          | (4) | Gauze Dressing Pads, 3" x 3"              |
| (1)  | CPR Face Shield                    | (2) | Trauma Pads, 5" x 9"                      |
| (1)  | Burn Dressing, 4" x 4"             | (1) | Triangular Sling/Bandage, 40" x 40" x 56" |
| (10) | First Aid/Burn Cream Packets, 0.9g | (1) | First Aid Guide                           |
| (1)  | Cold Compress, 4" x 5"             |     |   |
| (2)  | Sterile Eye Pads                   |     |   |
| (1)  | Eyewash, 1oz                       |     |   |



90562 25 Person, Plastic First-Aid Kit | \$25.99

## AED PLUS®



**IMPORTANT FEATURES:**  
Intelligent Pediatric Capability



### ZOLL MEDICAL AED PLUS

ZOLL's AED Plus® features Real CPR Help® for rate and depth of compressions. Support for the complete Chain of Survival and a one-piece electrode pad for fast and accurate placement. AEDs use consumer lithium camera batteries available from retail stores.

8900-0810-01 Medical AED Plusv | \$94.99  
8000-004000-01 ed+ Police Pkg w/Aed Cover | \$2,099.99



#### IMPORTANT FEATURES

Water-resistant, durable case.  
• Modern supplies to help manage severe bleeding, cardiac arrest, seizures, choking, and more. • The Mobilize Rescue App provides 'just-in-time' training to help untrained bystanders save lives. • Color-coded and numbered supplies match the app's instructions exactly.



Please call us for pricing and more info!

### MOBILIZE RESCUE SYSTEM COMPREHENSIVE

The Mobilize Rescue System helps untrained bystanders manage a spectrum of medical emergencies according to the protocols and best practices of the American Heart Association (AHA), Tactical Emergency Casualty Care (TECC), and the American College of Surgeons.

8911-001000-01 Mobilize Rescue SYS, COMPRHNSV | \$2,299.00  
8911-003000-01 Mobilize Rescue SYS, COMPACT | \$299.00





**WINGMAN PATROL BAG™**

**Dimensions:** 18.5" x 13.25" x 7.5"  
**Capacity:** 2393 cubic inch / 39 liters

56045-019 Wingman Patrol Bag | Black | \$89.99



**PROPPER® PATROL BAG**

Interior organization with additional see-through zippered bags, pen pockets, key clasp **Dimensions:** 18"L x 8"D x 11"H

F56920A001 Patrol Bag | Black | \$49.99



STANDARD



DELUXE

**CAR SEAT ORGANIZERS**

- Sits flat against the seat for accessibility
- Zippered front compartment keeps items secure

53561 Standard Car Seat Organizer | \$36.99

5256-2 Deluxe Car Seat Organizer | 36.99



**SIDE-ARMOR FIELD EQUIPMENT BAG**

- 1680D x 1680D Side-Armor material with water resistant
- I.D. Name strip compatible t coating
- **Dimensions:** 23.2" x 14.6" x 2.3" inches

53481 Field Equipment Bag | \$34.99



**SAUNDERS®**

CITATION HOLDERS AND ORGANIZERS



A



B



C

**STYLE A HOLDERS**

10003 4.25" x 9.5" | \$19.99

10006 4.75" x 10.25" | \$21.99

10007 5.67" x 9.5" | \$24.99

10017 8.5" x 12" | \$27.99

**B CRUISER-MATE®**

21017 Form Size: 8.5" x 12" | \$28.99

21018 Form Size: 8.5" x 14" | \$41.99

**C CITATION HOLDER II**

12205 Silver | \$24.99

12206 Black | \$24.99



**PRO-GARD™**

PORTABLE SEAT ORGANIZERS



A



B

- Portable design allows the organizer to move from car to desk to home
- Three Available Styles: Multi Slotted, Portable Printer and Open Slotted
- Pliable steel straps easily adjust to fit any seat for patrol officers
- Lightweight ABS construction is durable for long-term use
- Non-reflective finish prevents glare
- Mounts to any flat surface

A: D2950 Seat Organizers | Dimensions: 14" x 21" x 3.75" | \$82.00

B: D2951 Seat Organizers w/print mount | Dimensions: 14" x 21" x 3.75" | \$116.00



V100



**V100** Vault Small Pistol Case | Interior: 11" x 8" x 4.5" | **\$39.99**

**V730** Vault Tactical Rifle Case | Interior: 44" x 16" x 6.3" | **\$189.99**



V730

## VAULT SERIES

### GUN CASES

Built for hard use, high impact and supreme weather resistance, new Vault series gun cases are the most rugged and secure in their class.



## HEAVY-DUTY ROADSIDE KIT

- Kit includes 4 LED Warning Lights
- 9 Warning Light flash patterns
- Can be magnetically mounted
- AC/DC and cigarette adapters included
- Includes powerful scene lighting with a convenient charging case

**CT0010** LED (4-pack) Roadside Kit | **\$239.99**



## 6" INDUSTRIAL LIGHTSTICKS

- AML608HB** Blue | 8 hr | 10PAK | **15.99**
- AML608HW** White | 8 hr | 10PAK | **15.99**
- AML612HG** Green | 12 hr | 10PAK | **15.99**
- AML612HO** Orange | 12 hr | 10PAK | **15.99**
- AML612HR** Red | 12 hr | 10PAK | **15.99**
- AML612HY** Yellow | 1 hr | 10PAK | **15.99**



## HAT TRAP

Protects hat from sun and abuse when not in use. Also retains the flat shape of brim.

**HT-1** | **\$66.99**



Emergency Flares and Flare Storage Bags are also available separately. Please call us for info and pricing.

## ORION

### ASSORTED FLARE KITS

- 6030** (6-pack) Flare Kit w/ orange vest | 30-minute burn | **\$17.99**
- 7200** (36-pack) Flare Kit | 20-minute burn | **\$65.99**
- 1240** (36-pack) Flares w/ wire stand | 20-minute burn | **\$72.99**
- 0730** (36-pack) Flare Kit | 30-minute burn | **\$89.99**
- 9430** (36-pack) Flares w/ wire stand | 30-minute burn | **\$98.99**

## STREAMLIGHT



## SUPER BRIGHT PORTABLE SCENE LIGHT II

- Lumens** 10,000 high / 2,300 low
- Run Time** 2hrs high / 11hrs low
- Batterie(s)** Lithium Ion

**45670** Portable Scene Light II | **\$729.99**

## KEY FEATURES

Multi-level illumination for scene lighting; head swivels 360° and stackable frame.



**STREAMLIGHT**



**NEW**

**STAND**  
Integrated stand  
for scene lighting

**WAYPOINT® 300**  
RECHARGEABLE SPOTLIGHT

**Lumens** | 1000  
**Run Time** | 3.75hrs  
**Batterie(s)** | Lithium Ion

44910 Waypoint 300 Rechargeable Spotlight (Yellow) | \$121.99



**SL-20L® LED DC**

**Lumens** | 350  
**Run Time** | 2hrs  
**Batterie(s)** | Nickel-metal Hydride

20702 SL-20 LED | \$122.99

**EXTRAS**

We carry a full line of accessories for Streamlight.



**ULTRASTINGER® LED DC**

**Lumens** | 1100 h / 350 m  
**Run Time** | 1.5hrs h / 4.5hrs m  
**Batterie(s)** | Nickel-metal Hydride

77555 Ultra Stinger | \$136.99



**SIROCCO 600 W LED**

**Max Lumens** | 60,000  
**Lamps** | 6 x 100 W LED  
**Efficiency** | 100 lm/W  
**Max Power** | 600 W  
**Voltage** | 100~240 V / 50 Hz

SIR0293 Sirocco 2-M 600W LED

Call for pricing and availability

**O'HERRON OFFERS LIVE PRODUCT DEMOS**

**AIRSTAR**



**PORTABLE SCENE LIGHT**

**Lumens** | 5,300 max / 2,500 m / 1,300 l  
**Run Time** | 4hrs max / 9hrs m / 18hrs l  
**Batterie(s)** | Nickel-metal Hydride

45670 Rechargeable Scene Light | \$694.99

45680 Rechargeable Scene Light Extended Version | \$769.99

**STAND**

Extends to 72 inches [ extended version 84 inches ]

**STREAMLIGHT**



**MAG-LITE CHARGER SYSTEMS**

**MAG SYSTEMS**

RL1019 #1 - 12v DC cigarette lighter adapter & 110v AC converter | \$116.99

RL2019 #2 - 12v DC cigarette lighter adapter | \$111.99

RL3019 #3 - 110v AC converter | \$107.99

RL7019 #7 - 12v straight wire | \$101.99

**ACCESSORIES**

ARXX185 Charging unit (base bracket included, charging cord not included) | \$31.99

ARXX175 12v DC straight wire | \$16.99

ARXX235 Battery pack, 6v Ni-MH | \$35.99

**TRAFFIC WANDS**

ASXX07B Red traffic wand | \$5.99

ASXX08B Yellow traffic wand | \$5.99

**MAG-LITE®**



**BLUE/RED SAFETY LIGHT**

Has both a tight-beam long-throw flashlight and a wide-angle two colored flashing safety light array. Modes: momentary and constant-on flashlight, full-power safety light, alternating color flashing safety light and dual-light

- Two button design—top: flashlight, bottom: safety light
- Powered by 4 AA batteries (included)

NSP-1170 Blue/Red Safety Light | \$41.99



**NIGHTSTICK YELLOW AND RED SAFETY CONES**  
Fits 1060/1160/1170/1180 and 1260 Series LED Lights

1260-YCONE Yellow | \$3.45  
1260-RCONE Red | \$3.45

**NIGHTSTICK**



## SAFETY VESTS & REVERSIBLE RAIN GEAR



Blauer waterproof nylon 8 point hat Cover. (One size fits all)  
**107 Reversible Hat Cover**  
| High Vis | **\$49.99**



Sizes: S-M, L-XL, 2XL-3XL 4XL-5XL  
(oversize vests may incur extra cost)  
**339S 21" Sheriff** | **\$49.99**  
**339P 21" Police** | **\$49.99**  
**339 Vest w/ blank panels** | **\$39.99**



Sizes: S-M, L-XL, 2XL-3XL 4XL-5XL  
(oversize vests may incur extra cost)  
**343 21" Blank** | **\$49.99**



48" LONG

32" LONG

- 1Tech-lite urethane-coated 200-denier oxford nylon fabric reverses to hi-vis yellow.
- 2" Scotchlite™ reflective trim on hi-vis side around chest, cuffs and arms.

**26991 32" High Vis Rain Coat** | Colors: Black/Hi-Vis Yellow | S-3XL | **\$109.99**  
**26990 48" High Vis Rain Coat** | Colors: Black/Hi-Vis Yellow | S-3XL | **\$124.99**  
**123-XX-XX** Optional snap-on hood available | **\$13.99**



### PRO-LINE SAFETY

#### BARRICADE TAPES

Available in 2.0 mils, 3.0 mils, and 4.0 mils of structural thickness. Barricade tape is printed utilizing big, bold, black lettering.

- 3-5001** "Crime Scene Do Not Enter" | **\$13.99**
- 3-5002** "Police Line Do Not Cross" | **\$13.99**
- 3-5003** "Sheriff's Line Do Not Cross" | **\$13.99**
- 3-5004** "Security Line Do Not Cross" | **\$13.99**
- 3-5005** "Fire Line Do Not Cross" | **\$13.99**
- 3-5006** "Police Barrier Do Not Cross" | **\$13.99**
- 3-5000C** "Caution" | **\$13.99**
- 3-5008** "No Parking" | **\$13.99**
- 3-5009** "HAZ-MAT" | **\$13.99**



The Rolatape RT Series lightweight and quality construction makes them the perfect choice for interior design, home remodeling, crime scenes, construction, and real estate appraisals.



RT104

RT204

RT312

**RT104 MM12** single wheel model | **\$35.99**  
**RT204 MM12** twin wheel model | **\$41.99**  
**RT312 MM30** spoked wheel model | **\$79.99**



More Rolatape carry bags available.



### MEASURE TAPE BAGS

**32-100CCB** Carry bag for 112, MM12 & MM45 | **\$15.99**  
**32-30CCB** Carry bag for 300 & MM30 | **\$20.99**



### TAPE TENDER® DISPENSER

Dispense 1,000 FT roll of 3" barricade tape quickly, safely, and efficiently. Serrated cutting blade built in. Lightweight and indestructible polypropylene construction. Easy to load into dispensers. Helps reduce waste and snares.

**1010TAP** | Tape Tender | **\$21.95**

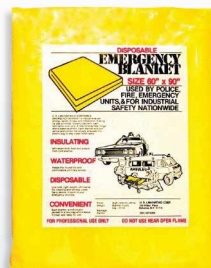

### DISPOSABLE EMERGENCY BLANKET

60" x 90"—inexpensive, heavy duty and it resists mildew and infestation. Waterproof, constructed with a layer of heavy duty film laminated over a layer of urethane foam. Blanket is high visibility yellow and comes individually packaged in a sealed plastic bag.

**35700** | Disposable Blanket | **\$7.50**



# STECK

## BIGEASY™ LOCKOUT TOOLS AND KITS

CATALOG #	DESCRIPTION	PRICE
32955	BigEasy™ GLO/ Easy Wedge Kit	\$73.00
32955DLX	BigEasy™ GLO/ Easy Wedge Kit With Case	\$100.00
32950	BigEasy™ GLO Kit	\$45.50
32900	Classic BigEasy™ Kit	\$38.00
32922	Easy Wedge, 7" x 7"	\$36.00
32923	Super Easy Wedge, 9" x 7"	\$50.00
32935	BigEasy™ Carrying Case	\$13.34
32924	BigEasy™ Paint Protector (Reduces friction between the car door and the BigEasy)	\$6.00
32903	BigEasy™ Loop (Helps with door handles and window cranks)	\$13.34
32905	BigEasy™ Extend (Snaps on the end of the BigEasy Tool)	\$13.34



32955DLX



32905



32903



32922



32955

## PRO-LOK® LOCKOUT TOOLS AND KITS



**1: ORIGINAL SLIM JIM**  
Made of stainless steel.  
¾" x 22½" x .032" thick.

AO-10 | **\$10.99**

**2: SUPER SLIM JIM**  
Made of stainless steel.  
1¼" x 25" x .032" thick.

AO-11 | **\$10.99**

**3: E-Z JIM**  
Made of stainless steel.  
1" x 25" x .042" thick.

AO-25 | **\$11.99**

**4: X-LONG SLIM JIM**  
Made of stainless steel.  
¾" x 29½" x .032" thick.

AO-30 | **\$12.99**



### ECONOMY KIT

The Economy Kit is a great inexpensive starter kit. The compact slim vinyl case allows for easy storage behind the seat for emergency calls. Includes two slim jims, two wire tools and a tool usage and instruction booklet. 6 piece set.

**AK-75 Economy Kit | \$37.99**



### 4 PIECE LONG ARM CAR OPENING TOOL KIT

Includes the Standard 58" Long Arm Tool [AO42-LA], Inflatable Pump Wedge [AO65], Mini Rubber Wedge [AO67] and the Long Arm Tool Protection Sleeve [AO42SL] to prevent damage to the car opening or window.

**AK42-LA Car opening tool kit | \$77.99**



### PUMP WEDGE

This inflatable wedge is made of non-marring vinyl material and has rounded corners for easy entry.

AO-65 | **\$35.99**



### GREY RUBBER WEDGE

Made from heavy-duty non-marring high grade rubber to assist in car openings.

AO-61 | **\$13.99**

# SPIKE SYSTEMS AND TRAFFIC CONTROL

## FEDERAL SIGNAL



### STINGER SPIKE STRIP

- 90210 Metro, 10 ft | \$569.00
- 90200 Trooper, 15.5 ft | \$719.99
- 90225STI Defender, 25 ft | \$1,158.99

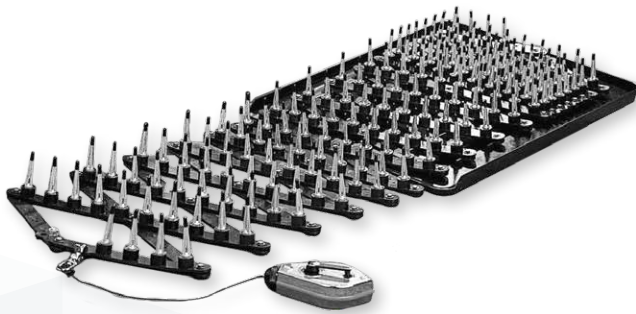

### MAGNUMSPIKE!®

- MS-12 Wrap and Roll, 12 ft | \$378.00
- MS-16 Wrap and Roll, 16 ft | \$451.00
- MS-25 In Hard Case, 25 ft | \$655.00

## AERVOE



### AERVOE®

- PORTABLE SPEED BUMP
- 1170 Portable Speed Bump, 10 ft | \$319.99

## SPIKE-DEVIL



### SPIKE-DEVIL

- 10010 Standard Size | \$247.99
- 10020 Wider Size | \$330.99



## END-X SYSTEMS

### PHANTOM SPIKE

These hand deployed spike strip systems include Phantom Spikes tethered together with a retrieval reel. These high performance spike strips are the most effective and safest tire deflation system available.

#### BOTH SYSTEMS FEATURE

- System weighs only 4 lbs and 11 oz
- Reel has 100' of line, 7.5 ft of lane coverage
- Comes with trunk mounting brackets or a protective storage bag
- Highly effective on ALL vehicles with 4 wheels or more
- Internal spikes every 2" & durable construction

- PT700 7.5' | \$350.00
- PT8007 10' | \$450.00



# STACK-ON®



**A**



**B**



**C**



**D**



**G**  
BIO-LOCK

## STACK-ON QUICK ACCESS SAFES

Provides instant access to your safe's contents. New keypads are back-lit for greater visibility in low light settings. Safes should be mounted to a solid surface to ensure the security of their contents.

### STACK-ON SAFE OPTIONS

- A:** PC-95C | \$29.99      **D:** GAS-1545 | \$79.99
- PC-95K-18 | \$29.99      **E:** GAS-1304-12 | \$128.99
- B:** QAS-1510 | \$83.99      **F:** PS-1514 | \$106.99
- C:** QAS-1514 | \$202.99      **G:** PDS-1500-B | Bio-Lock | \$89.99



### WEIGHT:

- 21.4 lbs / 9.7 kg no tips, no battery
- 24.3 lbs / 11.0 kg combi tips, no battery
- 25.8 lbs / 11.7 kg door opener tips, no battery



The StrongArm from HURST Jaws of Life® provides portable hydraulic power to use anywhere you deem necessary.

**273180000 | \$6,995.00**

*Hurst [Black Edition] Available to Law Enforcement Only.*

**O'HERRON OFFERS LIVE PRODUCT DEMOS**



## GO SHIELD

- Total 40 inches in length
- Folding positions to 30" or 25" for confined spaces
- Soft ballistic panels allow shield to unroll and provide instant protection (Separate storage bag included)

**CI11A-3522CD050 Go Shield | \$1328**

Front two plate pocket for use with 10" x 12" stand alone certified hard armor plates in Level III or IV (Hard armor plate not included)



## POINT BLANK STEEL PLATE CARRIER

- Front pockets accommodate 10x12 Shooters Cut Plate
- Back pockets accommodate 10x12 Full Size Plate
- Buckle system for quick donning and doffing
- One size fits most

**PCP000K10J Active Shooter Kit (2) 10X12 Inch 555 Steel plates with carrier | \$336.99**

The Point Blank Steel Plate Carrier includes a 10-year warranty.

**DANVILLE**

3549 N. VERMILION | DANVILLE, IL 61832  
 PHONE: 800-223-2097

**DOWNERS GROVE**

1600 75TH STREET | DOWNERS GROVE, IL 60516  
 PHONE: 630-629-2677

## SoundOff Signal

Check out the Intersector, a mirror mounted light from Sound Off Signal, Featured on **PG. 16**



## LEONARDO

See the new ELSAG License Plate Reader camera from Leonardo Featured on **PG. 27**



Take a look at StrongArm's Hurst [Jaws of Life] Featured on **PG. 35**



### GIFT CARDS & E-GIFT CARDS

O'Herron Gift Cards and our new special occasion selection of E-Gift Cards are great quick gifts for the special heroes in your life.

### VISIT OUR WEBSITE!

[WWW.OHERRON.COM](http://WWW.OHERRON.COM)

- Enjoy a Hassle Free Online Shopping experience.
- Mobile Friendly site for on-the-go purchasing.
- O'Herron Department Portals help entire departments save time and money.
- Sign up for exclusive offers and keep up to date on the latest from O'Herron's.

### CHECK US OUT ON SOCIAL MEDIA:

